

2017

2019 10

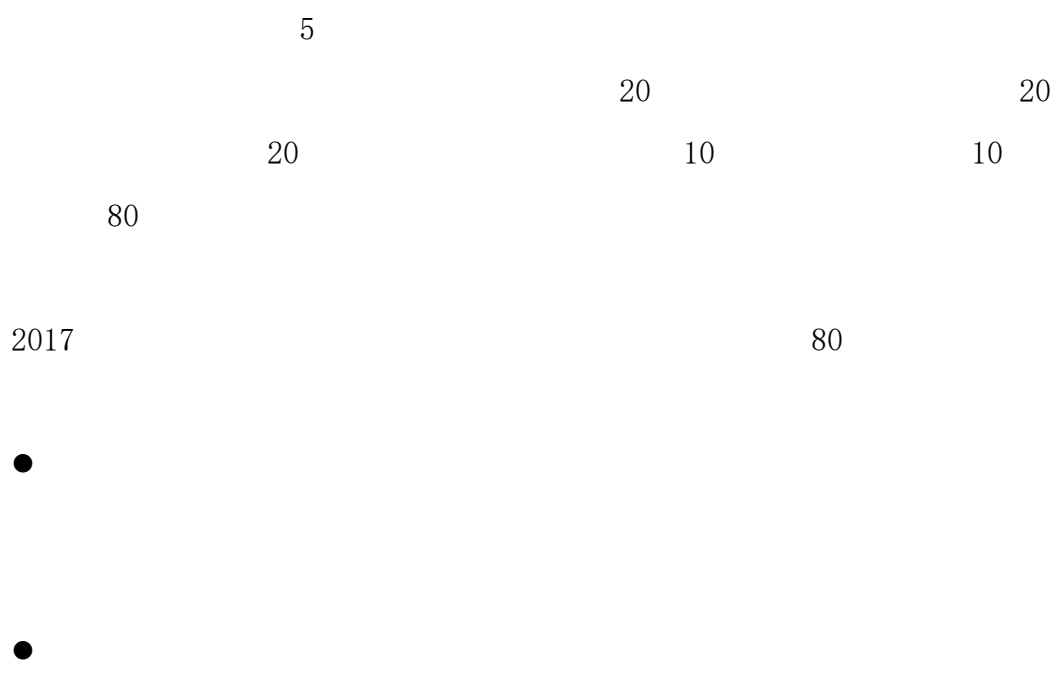

		1
		1
1.	1-1	1
2.	1-2	6
3.	1-3	11
4.	1-4	16
5.	1-5	20
6.	1-6	25
7.	1-7	30
8.	1-8	35
9.	1-9	40
10.	1-10	45
11.	1-11	50
12.	1-12	53
13.	1-13	56
14.	1-14	59
15.	1-15	62
16.	1-16	65
17.	1-17	68
18.	1-18	71
19.	1-19	74
20.	1-20	77
		80
		80
1.	2-1	80
2.	2-2	83
3.	2-3	85
4.	2-4	87
5.	2-5	89
6.	2-6	91
7.	2-7	93

8.	2-8	95
9.	2-9	98
10.	2-10	101
11.	2-11	104
12.	2-12	107
13.	2-13	110
14.	2-14	113
15.	2-15	116
16.	2-16	119
17.	2-17	122
18.	2-18	126
19.	2-19	130
20.	2-20	133
		136
1.	3-1	136
2.	3-2	140
3.	3-3	145
4.	3-4	149
5.	3-5	154
6.	3-6	159
7.	3-7	164
8.	3-8	169
9.	3-9	174
10.	3-10	179
11.	3-11	184
12.	3-12	186
13.	3-13	188
14.	3-14	190
15.	3-15	192
16.	3-16	194
17.	3-17	196
18.	3-18	198
19.	3-19	200
20.	3-20	202

		204
		204
1.	4-1	204
2.	4-2	207
3.	4-3	210
4.	4-4	213
5.	4-5	216
6.	4-6	219
7.	4-7	222
8.	4-8	225
9.	4-9	228
10.	4-10	231
		234
1.	5-1	234
2.	5-2	236
3.	5-3	238
4.	5-4	240
5.	5-5	242
6.	5-6	244
7.	5-7	246
8.	5-8	248
9.	5-9	250
10.	5-10	252

1. 1-1

1

33 2100 10 2010
310 1995

1

3 5

1.2

1.2

2003

ABC

1

1

Handwritten-style characters and symbols, including a large 'X' and various loops and flourishes.

+

3

7

3

|| v

E I

10

0

10

2000

8 e

W

■ ■

a

2

1-1

10		10	6S 0/3/5		
		0/3/5			
90	20			16-20	
				11-15	
				6-10	
				1-5	
				0	
	9			8-9	
				6-7	
				4-5	
				0-3	
		21	/	21	

			/	18	
			/	15	
			/	12	
			/	9	
			/	6	
			/	3	
				0	
		20	15		

			0/3/5	
		20	5 5	
			6 4	
	100			

-

2. 1-2

1

2002

0-16

1

:// . .

4

2

3

3

7

4

10

200

500

120

5

		()	10%	(
	20%	800		80
	30%	112		11.2
	50%	88		8.8

A.

?

B.

2

7 8

0 2010

3

60

4

1-2

1-2

10		10	6S 0/3/5			
				0/3/5		
90	20			16-20		
				11-15		
				6-10		
				1-5		
				0		
	9			8-9		
				6-7		
				4-5		
				0-3		
		21	/		21	

			/	18	
			/	15	
			/	12	
			/	9	
			/	6	
			/	3	
				0	
		20	15		

			0/3/5	
		20	5 5	
			6 4	
	100			

3. 1-3

1

14

4

DSR

1

14

://

34091294.

. /

14

4

2

14

14

3

70

14

7

4

14

20

500

14

1500

14

350

5

14

		()	10%	(
	20%	40000		4000
	30%	8000		800
	50%	2000		200

A.

?

B.

2

7 8

0 2010

3

60

4

1-3

1-3

6S

0/3/5

10

10

			/	18	
			/	15	
			/	12	
			/	9	
			/	6	
			/	3	
				0	
		20	15		

			0/3/5	
		20	5 5	
			6 4	
	100			

4. 1-4

1 N F 1966

7 DSR

1 :// . .

2 4

3 3000

4 7 ***

4 20

500

1500

350

5

		()	10% (
	20%	4000	400
	30%	800	80
	50%	200	20

- A. ?
- B.

2

7 8

0 2010

3

60

4

1-4

1-4

			6S 0/3/5		
10	10		0/3/5		
90	20			16-20	
				11-15	
				6-10	
				1-5	
				0	
	9				8-9
					6-7
					4-5
					0-3
	21		/		21
			/		18
			/		15

			/	12	
			/	9	
			/	6	
			/	3	
				0	
			15		
		20	0/3/5		
			5	5	
		20	6	4	
	100				

5. 1-5

1

200

DSR

1

:// 71054329. /

4

2

3

7

4

30

5

2

20

15

5

		()	10%	(
	20%	400		40
	30%	80		8
	50%	20		2

A.

?

B.

2

7 8

0 2010

3

60

4

1-5

1-5

			6S		
10	10		0/3/5		
			0/3/5		
90	20			16-20	
				11-15	
				6-10	
				1-5	
				0	
	9				8-9
					6-7
					4-5
					0-3
		21		/	21

			/	18	
			/	15	
			/	12	
			/	9	
			/	6	
			/	3	
				0	
		20	15		

			0/3/5	
		20	5 5	
			6 4	
	100			

6. 1-6

1

DSR

1

:// 36830724. . /

4

2

3

7

4

30

50

2

100

40

5

		()	10%	(
	20%	400		40
	30%	80		8
	50%	20		2

A.

?

B.

2

7 8

0 2010

3

60

4

1-6

1-6

10		10	6S 0/3/5		
		0/3/5			
90		20		16-20	
				11-15	
				6-10	
				1-5	
				0	
		9		8-9	
				6-7	
				4-5	
				0-3	
		21	/	21	

			/	18	
			/	15	
			/	12	
			/	9	
			/	6	
			/	3	
				0	
		20	15		

			0/3/5	
		20	5 5	
			6 4	
	100			

7. 1-7

1

DSR

1

:// . . /

4

2

3

R D

7

4

50

60

2

80

40

5

		()	10%	(
	20%	400		40
	30%	80		8
	50%	20		2

A.

?

B.

2

7 8

0 2010

3

60

4

1-7

1-7

				6S 0/3/5		
	10	10				
			0/3/5			
90		20		16-20		
				11-15		
				6-10		
				1-5		
				0		
		9		8-9		
				6-7		
				4-5		
				0-3		
			21	/	21	

			/	18	
			/	15	
			/	12	
			/	9	
			/	6	
			/	3	
				0	
		20	15		

			0/3/5	
		20	5 5	
			6 4	
	100			

8. 1-8

1

4

DSR

1

://

.

.

/

4

2

3

4 6+128G

7

4

10

50

1

2000

1200

5

		()	10%	(
	20%	8000		800
	30%	1500		150
	50%	500		50

A.

?

B.

2

7 8

0 2010

3

60

4

1-8

1-8

				6S 0/3/5		
	10	10				
			0/3/5			
90		20		16-20		
				11-15		
				6-10		
				1-5		
				0		
		9		8-9		
				6-7		
				4-5		
				0-3		
			21	/	21	

			/	18	
			/	15	
			/	12	
			/	9	
			/	6	
			/	3	
				0	
		20	15		

			0/3/5	
		20	5 5	
			6 4	
	100			

9. 1-9

1

3

DSR

1

:// . . /

4

2

3

5-6

7

4

20

40

3

50

35

5

		()	10%	(
	20%	400		40
	30%	80		8
	50%	20		2

A.

B.

1-9

10		10	6S 0/3/5			
		0/3/5				
90	20			16-20		
				11-15		
				6-10		
				1-5		
				0		
	9			8-9		
				6-7		
				4-5		
				0-3		
		21		/	21	

			/	18	
			/	15	
			/	12	
			/	9	
			/	6	
			/	3	
				0	
		20	15		

			0/3/5	
		20	5 5	
			6 4	
	100			

10. 1-10

1

5

DSR

1

:// . . /

4

2

3

H -704B

7

4

5

50

1

200

50

5

		()	10%	(
	20%	4000		400
	30%	800		80
	50%	200		20

A.

?

2

7 8

0 2010

3

60

4

1-10

1-10

10		10	6S 0/3/5		
		0/3/5			
90		20		16-20	
				11-15	
				6-10	
				1-5	
				0	
		9		8-9	
				6-7	
				4-5	
				0-3	
		21	/	21	

			/	18	
			/	15	
			/	12	
			/	9	
			/	6	
			/	3	
				0	
		20	15		

			0/3/5	
		20	5 5	
			6 4	
	100			

11.

1-11

1

2

1	
1	
2	
2	
3	
3	
4	
4	
5	
5	

3

3

200

3

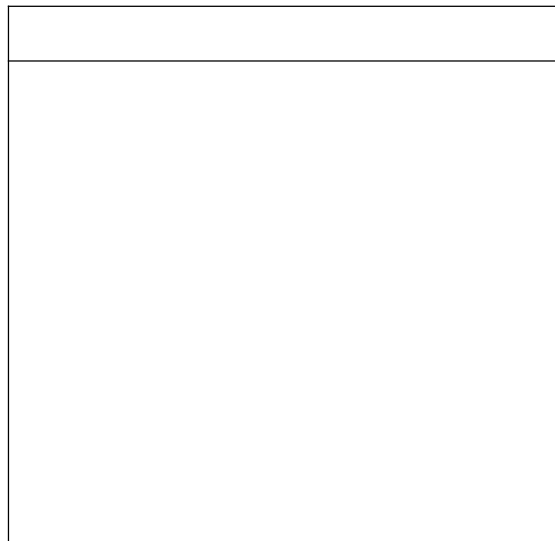

2

7 8 0 2010

3

60

4

1-11

10	10	6S	0/3/5
			0/3/5
90	25	5	
		16-20	
	35	11-15	
		6-10	
30	0-5		
	29-35		
	22-28		
	15-21		
		8-14	
		0-7	
		0/3/5	
		18-25	
		10-17	
		0-9	
		100	

12. 1-12

1

2000 4 20

GSM TD-SCDMA 518

2011

500 87

50

30 15

15

1

1 40

1

2

:

7 21 30 15

11 12

11 12

11 12

2

2

1	
1	
2	

2	
3	
3	
4	
4	
5	
5	

3

3

200

3

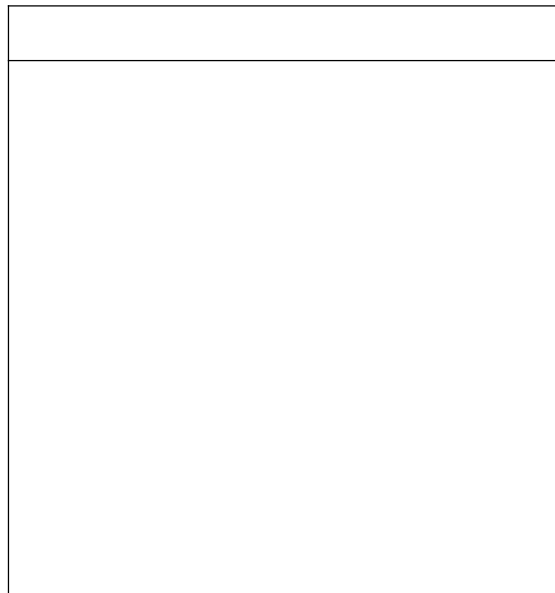

2

7

8

0

2010

3

60

4

1-12

1-12

6S

0/3/5

10

10

13. 1-13

1

:// . . /

200

800

6 11

6 6

20

6 10

1145

6 8

6

8

6 10

6 8

1145

1

1

40

1

2

:

6 8

6 10

2

2

1	
1	
2	
2	
3	
3	
4	
4	
5	
5	

3

3

200

3

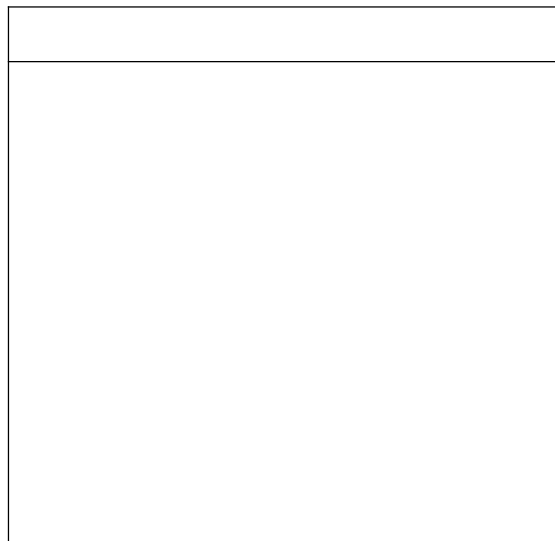

2

7 8

0 2010

3

60

4

1-13

1-13

10	10	6S	0/3/5
			0/3/5
90	25	5	
		16-20	
		11-15	
		6-10	
		0-5	
90	35	29-35	
		22-28	
		15-21	
		8-14	
		0-7	
		0/3/5	
90	30	18-25	
		10-17	
		0-9	
		100	

14. 1-14

1

4

5 2

5 6

1

1

40

1

2

:

2

2

1	
1	
2	
2	
3	
3	
4	
4	

5	
5	

3

3

200

3

2

7 8

0 2010

3

60

4

1-14

10	10	6S	0/3/5
			0/3/5
90	25	5	
		16-20	
	35	11-15	
		6-10	
30	29-35		
	22-28		
	15-21		
	8-14		
		0-7	
		0/3/5	
	18-25		
	10-17		
	0-9		
		100	

15. 1-15

1

2015 3 17

198

32G U 3 19

U

U

1G

32G

1

1

40

1

2

U

32G U

1G

2

2

1	
1	
2	
2	
3	
3	
4	
4	
5	
5	

3

3

200

3

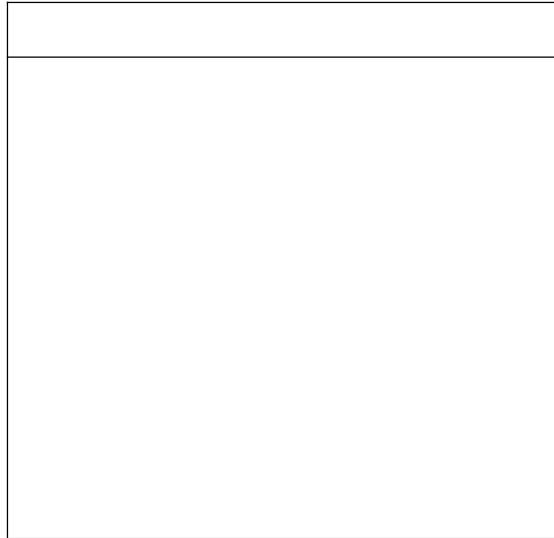

2

7

8

0

2010

3

60

4

1-15

1-15

6S

0/3/5

10

10

16. 1-16

1

(:// . . . /)

5

2018 2 6

200

2

1

1

40

1

2

2

2

2

1	
1	
2	
2	
3	
3	
4	

4	
5	
5	

3

3

200

3

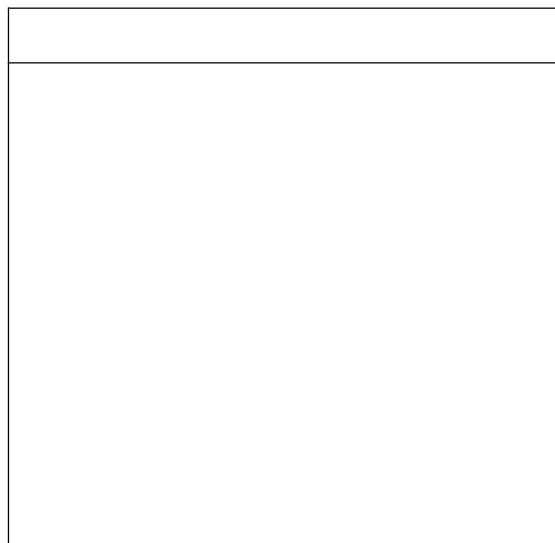

2

7

8

0

2010

3

60

4

1-16

1-16

10	10	6S	0/3/5
			0/3/5
90	25	5	
		16-20	
	35	11-15	
		6-10	
30	0-5		
	29-35		
	22-28		
	15-21		
		8-14	
		0-7	
		0/3/5	
		18-25	
		10-17	
		0-9	
		100	

17. 1-17

1

B2C

+

199 /

4

4

199

1

1

40

1

2

2

2

1	
1	
2	
2	
3	
3	
4	
4	

5	
5	

3

3

200

3

2

7

8

0

2010

3

60

4

1-17

10	10	6S	0/3/5
			0/3/5
90	25	5	
		16-20	
	35	11-15	
		6-10	
30	29-35		
	22-28		
	15-21		
	8-14		
		0-7	
		0/3/5	
	18-25		
	10-17		
	0-9		
		100	

18. 1-18

1

1999

17

25000

2003 12

9000

2015 10 26

2015 12 15

2015 12 25

28445467318

(12

25)

()

1

1

40

1

2

12 25

2

2

1	
1	
2	
2	
3	
3	
4	
4	
5	
5	

3

3

200

3

2

7 8 0 2010

3

60

4

1-18

10	10	6S	0/3/5
			0/3/5
90	25	5	
		16-20	
	35	11-15	
		6-10	
30	29-35		
	22-28		
	15-21		
	8-14		
		0-7	
		0/3/5	
	18-25		
	10-17		
	0-9		
		100	

19.

1-19

1

100%

150

1000

1

1

40

1

2

150

1

1000

2

2

1	
---	--

1	
2	
2	
3	
3	
4	
4	
5	
5	

3

3

200

3

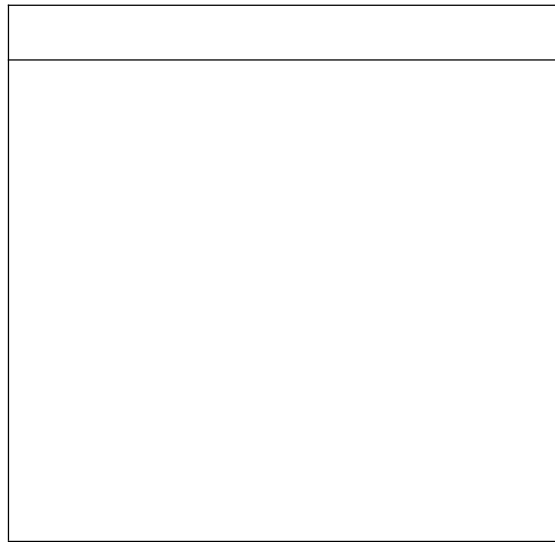

2

7 8

0 2010

3

60

4

1-19

1-19

10	10	6S	0/3/5
			0/3/5
	25	5	
		16-20	
90	35	11-15	
		6-10	
		0-5	
	35	29-35	
		22-28	
		15-21	
		8-14	
		0-7	
	30	0/3/5	
		18-25	
		10-17	
		0-9	
		100	

20. 1-20

1

:// . . / 2014 4

0 12

APP 2019 3 2

150

1

1

40

1

2

2016 3 2

150

2

2

1	
---	--

1	
2	
2	
3	
3	
4	
4	
5	
5	

3

3 200
3

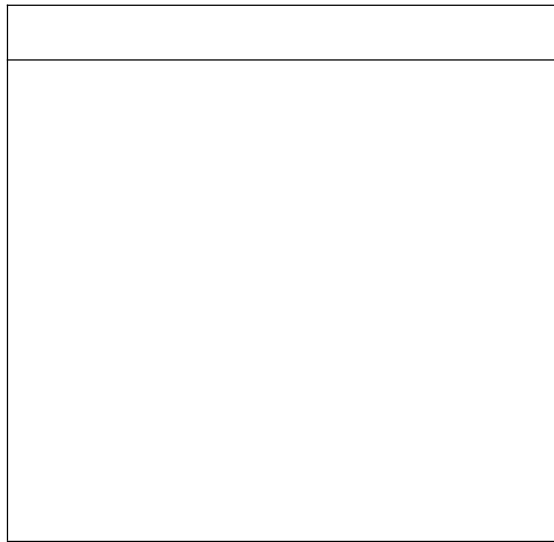

2

7 8 0 2010

3

60

4

1-20

1-20

10	10	6S	0/3/5
			0/3/5
90	25	5	
		16-20	
	35	11-15	
6-10			
0-5			
29-35			
22-28			
30	15-21		
	8-14		
	0-7		
	0/3/5		
30	18-25		
	10-17		
	0-9		
		100	

1. 2-1

1
B N

58 /

950 400

. . . 1.
2. 3.

1

. . .

100KB

2

P 7 8 0 20010
3 CS6.0
4 60
(2-1)

2. 2-2

1

1860 /

3

150

30

50

6

1

950

350

.

.

1.

2.

3.

1

.

.

.

100KB

2

7 8

0 2010

P

CS6.0

3

60

4

(2-2)

(2-2)

(10)	10	5	6S PSD
	5	3	2
	10	5	5
	20	10	5
	25	5	5
(90)	10	5	3
	10	5	3
	5	1	2
	5	2	2
	100		

3.

2-3

1

950

400

1

100KB

2

7 8

0 2010

P

CS6.0

3

60

4

(2-3)

(2-3)

4. 2-4

1

+

950 350

1.

2.

1

100KB

2

7 8

0 2010

P

CS6.0

3

60

4

(2-4)

(2-4)

(10)	10	5	6S PSD
	5	3	5 2
	10	5	5
	20	10	5
	25	5	5
(90)	10	5	3
	10	5	3
	5	1	2
	5	2	2
	100		

5. 2-5

1

790

72 /

/

3

3

.PSD

.JPG

2

7 8

0 2010

P

CS6.0

3

60

4

(2-5)

(2-6)

(10)	10	5 6S PSD	5
(90)	15	3 4	3 /
	12		3 /
	15	1 0-5 2 2 6-10 3 3	3 3 3 11-15
	10	5	3 2
	15		5 5 0 /2 /3 /4 /5
	8	4	4
	5		0 /2 /3 /4 /5
	10		2 6
		100	2

2-7

(10)	10	5 6S PSD	5
(90)	15	3 4	3 /
	12		3 /
	15	1 0-5 2 2 6-10 3 3 11-15	3 3 3
	10		3 5 2
	15		5 5 0 /2 /3 /4 /5
	8		4
	5		4
	10		0 /2 /3 /4 /5 2 6
		10	2
	100		

8. 2-8

1

L B

1) L

80 80 80 /

L .PSD

.JPG

JPG

150K

2) B

1920 500 100 /

1. 2 .

B

B

B

L

.PSD

.JPG

JPG

150K

3)

2

800 800 72 /

* *

1. 2.

3M

2

7 8 0 2010

P

CS6.0

3

60

4

(2-8)

(2-8)

			6S			5
(10)	10					PSD
				5		
L	18				2	
	4					
		2				
	10				5	
			5			
	4			2		2
B	30					
	4				2	
		2				
	8		5			

(90
)

9. 2-9

1

SK-II

L B
1) L

80 80 80 /

.JPG .PSD
150K JPG

2) B
1920 500 100 /

B
B L
.PSD

.JPG
150K
3) 800 2 800 72 /

* *

1. JPG 2. JPG

3M

2

7 8

0 2010

P

CS6.0

3

60

4

(2-9)

(2-9)

(10)	10	6S 5 PSD 5	5
L 18			
	4	2	2
	10	5	
	4	2	2
B 30			
	4	2	
	8	5	3
	14	B L 2 3 3 3	
	4	2	2
(90)	42		
	4	2	
	14	2 3 2	
	16	7 2 14 3	
	8	5 8 2 16	
	8	2 2 8	2
	100		

10. 2-10

1

L B

1) L

80 80 80 /

L

. PSD

. JPG

JPG

150K

2) B

950 120 100 /

B

B

B

L

. PSD

. JPG

JPG

150K

3)

2

800 800 72 /

* *

1. JPG

2. JPG

3M

2

7 8 0 2007 P
CS6.0
3
4
60
(2-10)

(2-10)

6S

5

(10)

10

PSD

6

11. 2-11

1

778

76

B

P

1

P

2

1

K

1

P

1

2

MM

K

U .

CSS

CSS

12

2

#CC0000

7 8

0 2010

P

CS6.0

D



2-11

(10)	10	5	6S
			5
B	12	2	2
		2	4 2
	10	2	5
	10		3
			4
	8	K	2
		2	2
(90)	10	7	3
	15	5	5
		5	
	10		4
CSS	15		5
		5	5
	100		

12.

2-12

1

1



1

1.

1.

1.

1.

1

2.

3.

4.

2.

3.

1

5.

6.

4.

5.

6.

4.

4.

.

1.

3.

4.

4.

LVSEHPIN

ISHIGAODIAN

BINFENSHIJIE

://
B CSS
16 1.5 :
:
K
2
7 8 0 2010
P CS6.0 D CS6
3
60
4
(2-12)

2-12

(10)	10	5	6S
			5
B	10	L	5 5
	8	1	5
		3	
	15		3 9
			3 3
		3	
	10		2 4
			6 0
	10		4 0-6
(90)	10		2 4
			2 5
	17	:	5 :
			5
	10	K	2
			3
		2	3
	100		

13. 2-13

1

M T

200*120

N C S

MITING

1

L



[首页](#)

[关于我们](#)

[公司产品](#)

[联系我们](#)



新品上市



护肤系列



彩妆系列



©版权所有 米婷日化公司 QQ交谈

1

CSS

CSS

CSS

24

#990000

CSS

1

2

3

150

120

1

10



1

K

2

7 8

0 2010

P

CS6.0

D

CS6

3

60

4

(2-13)

2-13

(10)	10	5	6S
			5
	10	2	2
		2	2
		2	
	15	0-9	9-12
		12-15	
	16	2	2
			2
C	20		3
			3
(90)	5		
			5
	14		3
		3	3
			3
	10	K	2
			3
		2	3
	100		

14. 2-14

1

H S D

LOGO

H S D

: 1. 2. 3.
 4. 12
 173 404

1. 1. 1.
 1. 1. 1.

1.

1 4

2. 3.

#FF4615

#0887DE

#FDE52A

#B9EE13



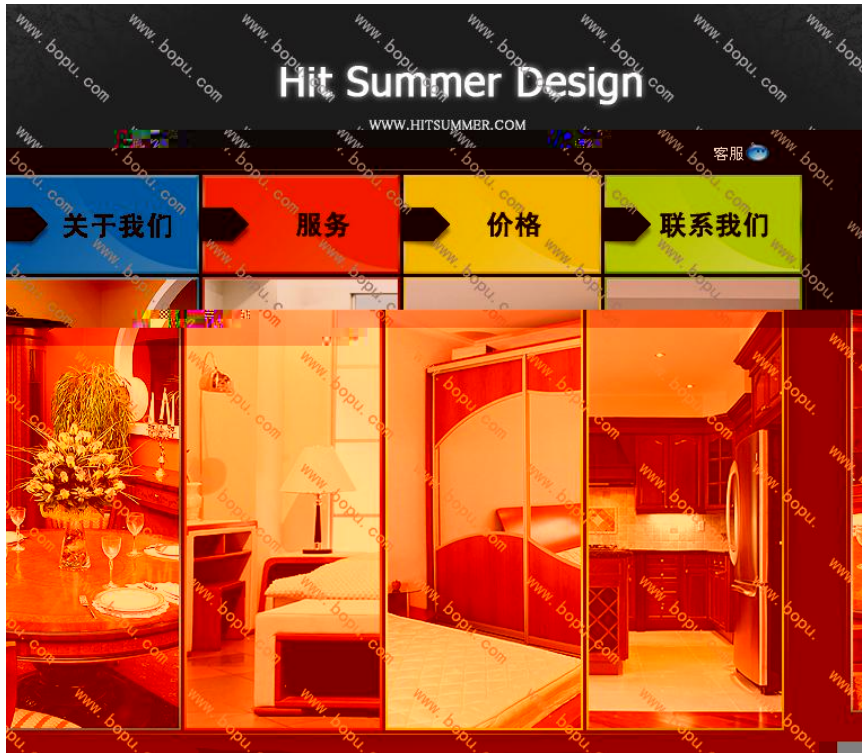

1

K

:// . . / :// . . . / :// . . . /

2

7 8 0 2010

P CS6.0 D CS6

3

60

4

(2-14)

2-14

(10)	10	5	6S
			5
L	6	LOGO	0-2 /3-4 /5-6 H S D 0
	12	1	
	18	2	2
	20	0-1 /2-3 /4	4
(90)	14	0-10	2 2
	4	2	2
	8	K	2 2
	8	2	2
	8		2
	100		

15. 2-15

1

1

1.

2.

700

230

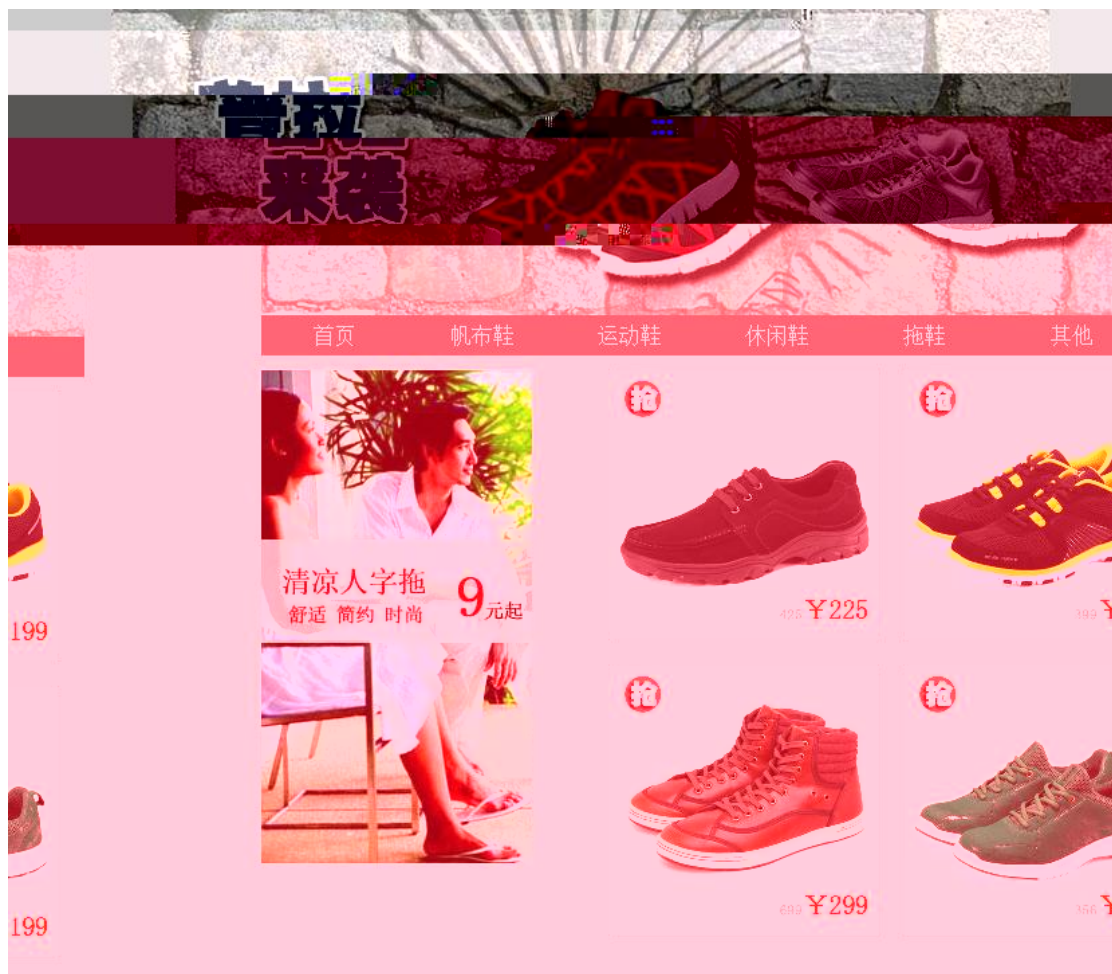

1

1

1.

4.

1

2

#FF0000

#FFFFFF

3

4

1

.

#CCCCCC

K

1.

:// . . /

2

7

8

0

2010

P

CS6.0

D

CS6

3

60

4

(2-15)

2-15

(10)	10	5	6S
			5
B	16	2	0 /1-3 /4-5 0/1-3/4-5
			2 0-2 /3-4
	20	1	4 2 0 /1 1 2
	29		0-15 2 2 12
(90)	6	2	2 2
	10		K 2 3 2 3
	9		5 2
	100		

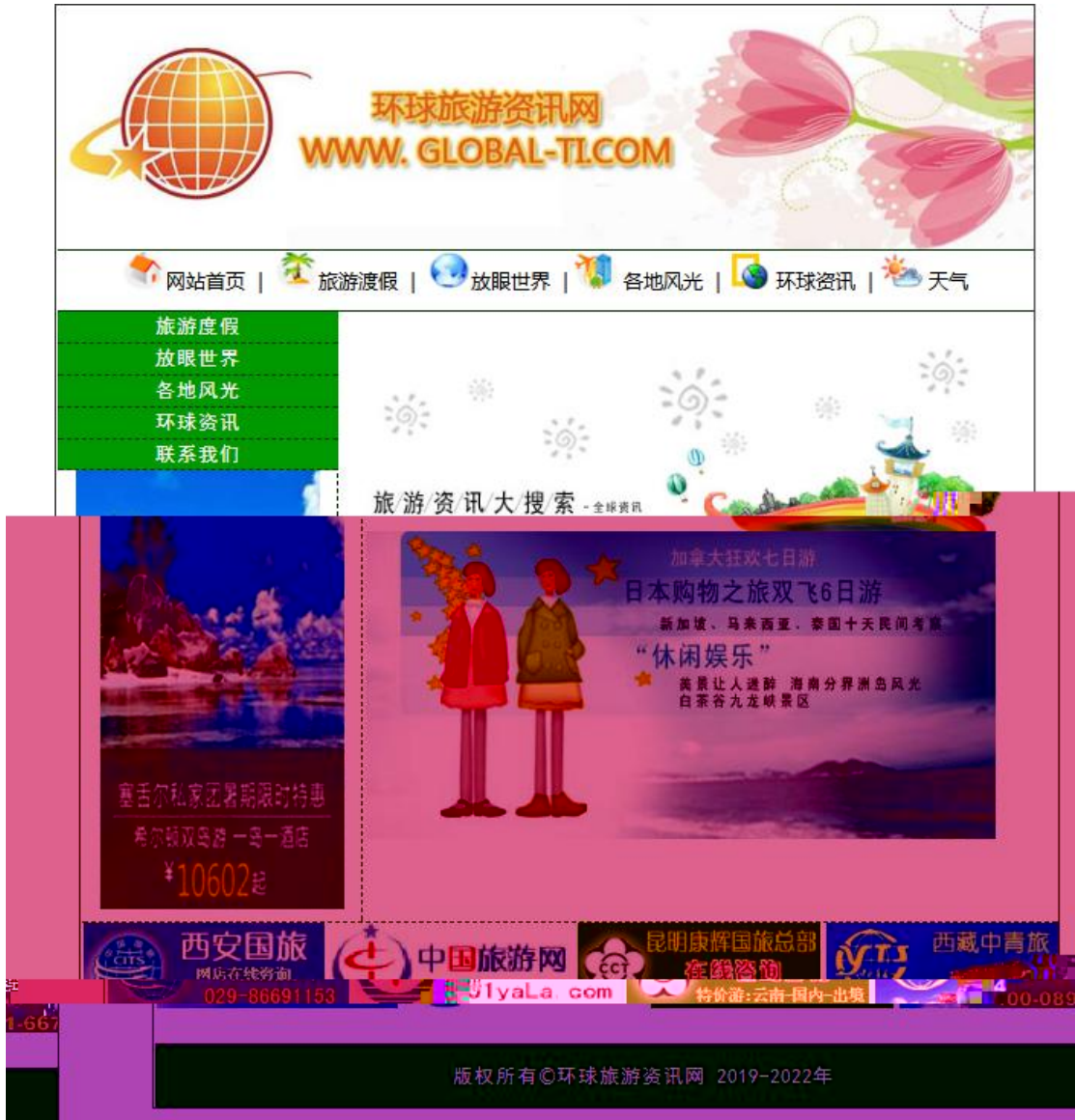

1

2

7 8 0 2010

P CS6.0 D CS6

3

60

4

(2-16)

2-16

(10)	10	6S 0 /3 /5 0 /3 /5	
(9 0)	15	LOGO 2 3 B 2 2 3	
	10	2 2 4 2	
	20	5 10 1	
	7	3 4	
	20	2 2 5 0-5	
	8	3 5	
	10	K 3 2 3	2
	100		

17. 2-17

1

SKINFOOD

01.

LOGO

SKINFOOD

A

24

-45

10

01

04.

04

-2.

400

350

01

04

01.

04.

-2.

1



1

3.

3.

1000

540

2

1.

2.

490

450

2.

1.

2.

2

DIV

1.

2.

2

1.



1.

2.

1

50

#DBCAAC

#623F23

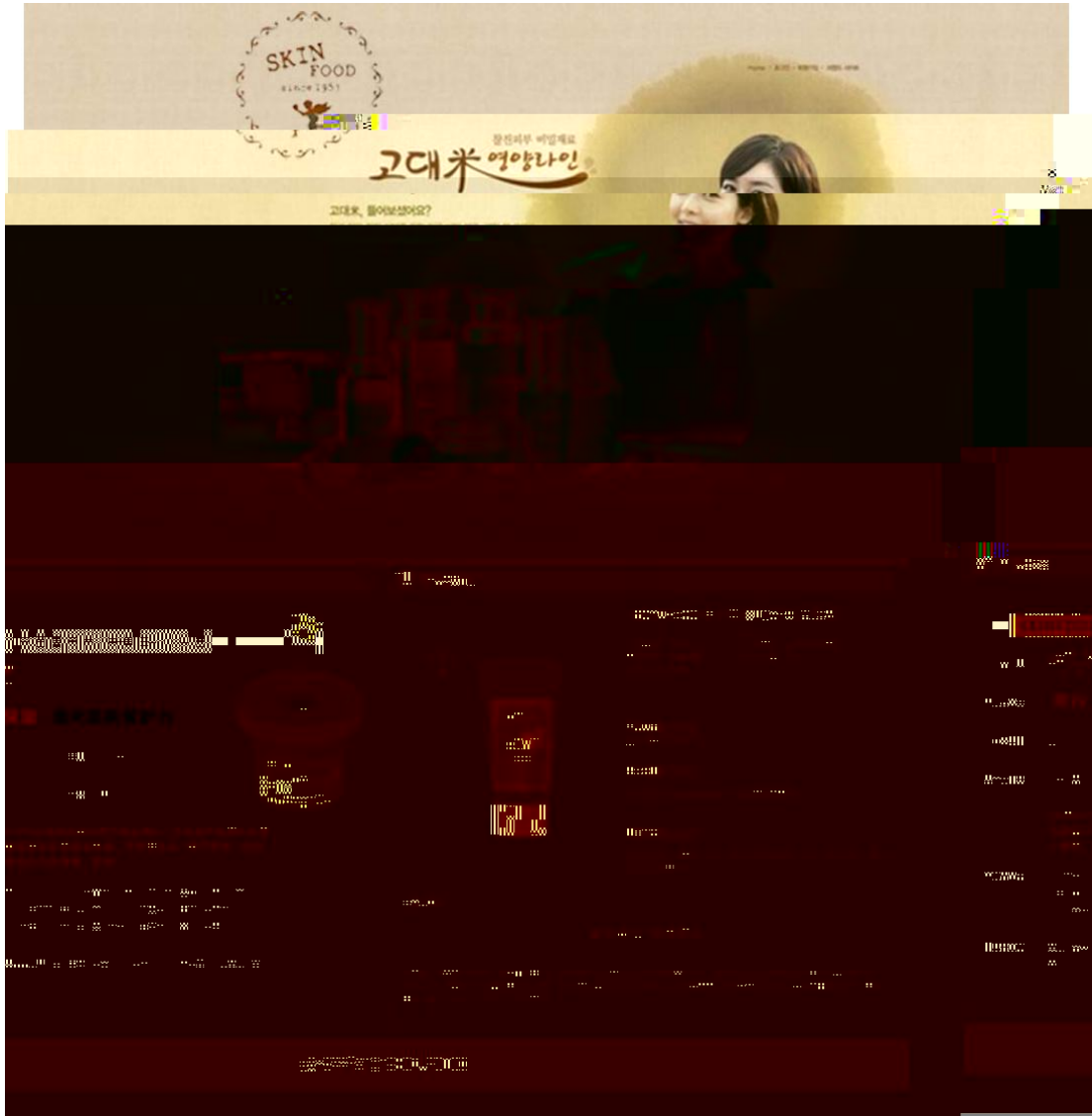

2

K

2

P

7 8

0 2010

CS6.0

D

CS6

3

60

4

(2-17)

2-17

(10)	10	5	6S
			5
LOGO	13	2	
		3	
		2	2
	9	2	3 2
		2	
	5	3	2
	5	1	3
	12	2	LOGO 5
		3	
(90)		2	
	10		2 1
		3 2	3
	20	5	2 2
		6	
	6	K	1
		2	
		1	2
	10	5	5
	100		

18.

2-18

1

01.

18

01 .

4

-1.

-1.

. /

01 .

4

24.

27.

29.

31.

24.

1

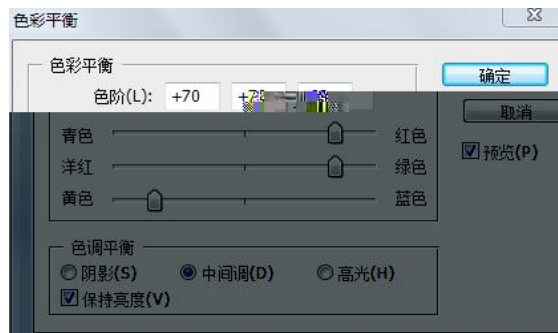

1

27.

2

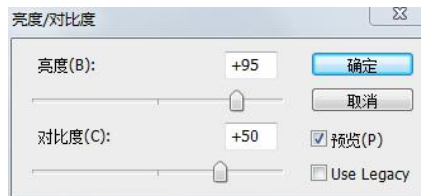

2

29.

3

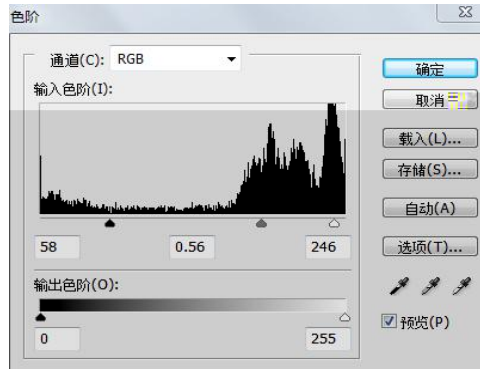

3

29. . 24. 27.
31. 01. .

B

4

12

2

16

2

4



4

K

2

P

3

4

7 8

0 2010

CS6.0

D

CS6

60

(2-18)

2-18

(10)	10	5	6S
			5
(90)	L	12	2 3
			2 1
	B	16	4 4
			2 3
		14	2 2
		4	2
		8	2 2 2
		16	3 3
		12	2 10
	8	K 2 2	
		2 2	
	100		

19.

2-19

1

. TTF

1

700*450

350

110

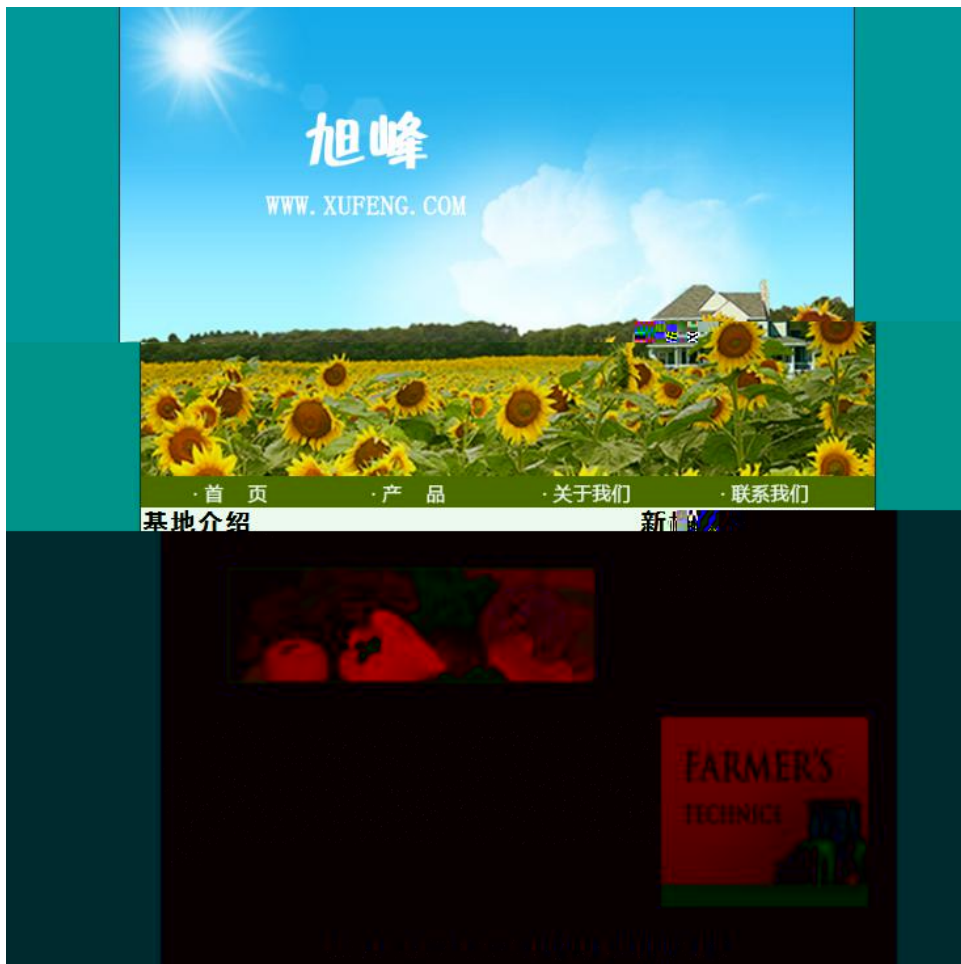

1

2 4

170 30

1.

2.

3.

4.

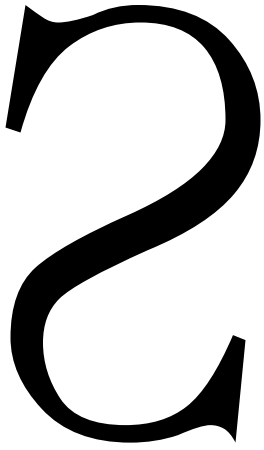

· PRODUCT

1 2

CSS

CSS

14

1.5

1

14

24

2

.

.

.

.

#009999

K

2

7 8

0 2010

P

CS6.0

D

CS6

2-19

			6S			
(10)	10	5				
				5		
(90)	B	13	3	2	2	
			2	2	2	
		4	2	2		
		12	3			
		6		1		
		10	5		5	
	CSS	17		5		
			6			
		16	2	2		
		4	2		2	
	8	K		2		
		2	2			
	100					

20.

2-20

1

1- 6 400*300

#000000

#FF0000

B 1 B 2

6 2 3

200*150 1

1 #1E6E87 150 20

#1E6E87 50 20

K

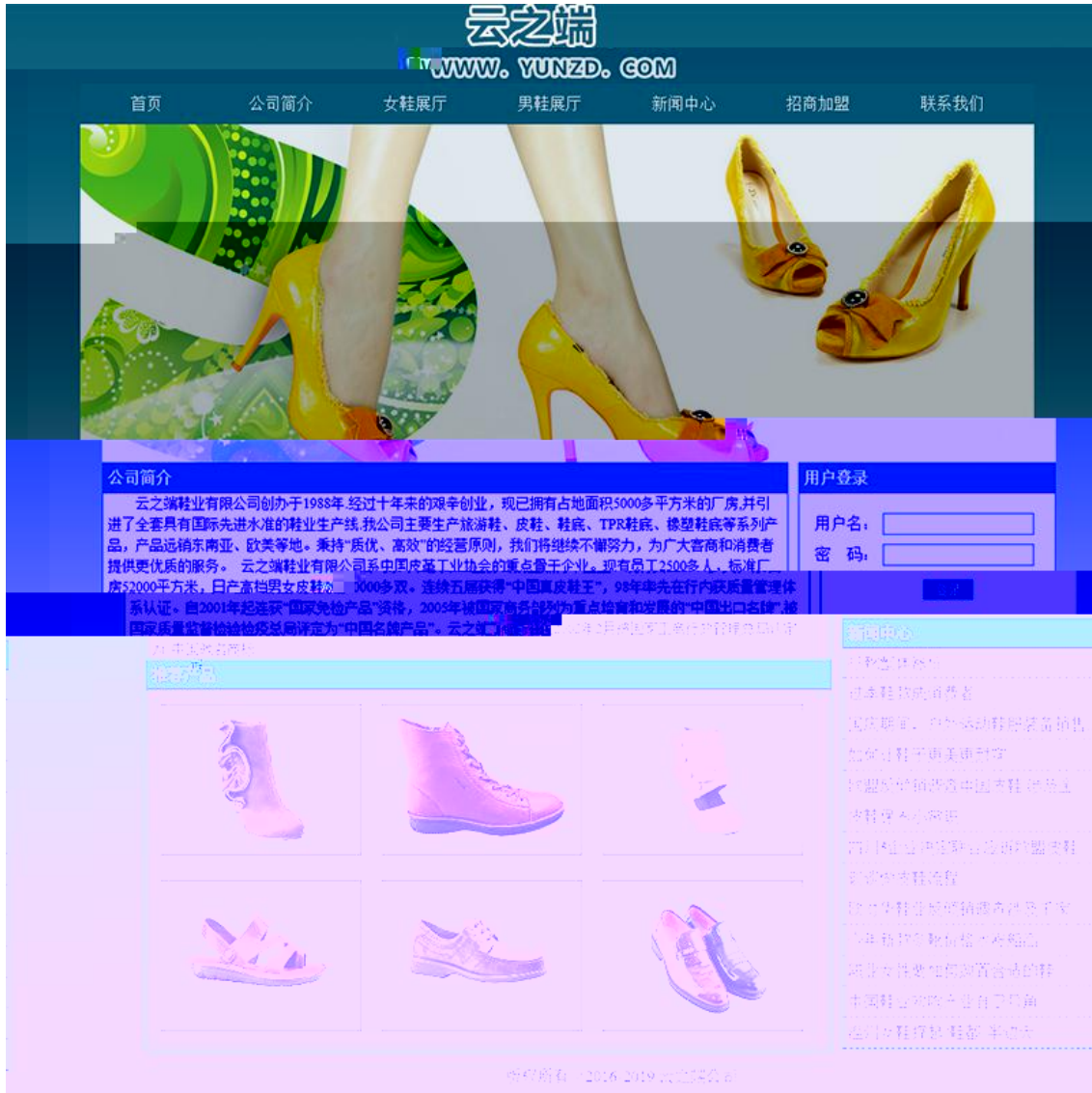

1

2

P 7 8 0 2010
CS6.0 D CS6

3

60

4

(2-20)

2-20

(10)	10	5	6S
			5
	10	3	4
		3	
	18	1	2
	8	2	2
		2	2
	22	5	5 2 3 5
		5	2
(90)	18	3	9
		3	3
	6		3
		3	
	8	K	2
			2
		2	2
	100		

1. 3-1

1
1

200

2

4

T

T

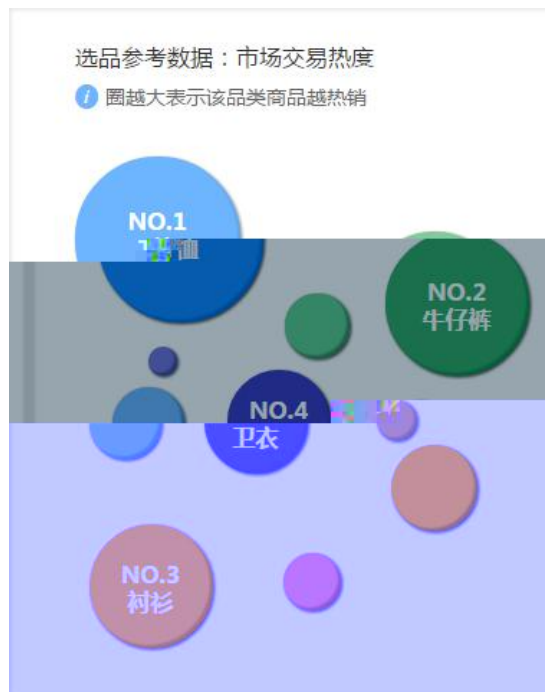

3

The screenshot displays a procurement system interface with a table of purchase quantity ranges and unit prices. The table is organized into rows for different item categories: 'T恤' (T-shirt) and '牛仔裤' (Jeans). Each row contains multiple columns representing different quantity ranges and their corresponding unit prices. The interface includes a search bar at the top, a navigation menu on the left, and a footer with icons.

Item Category	Quantity Range	Unit Price
T恤	1-1000件	195元/件
	1001-2000件	190元/件
	2001-3000件	185元/件
	3001-4000件	180元/件
T恤	4001-5000件	175元/件
	5000件以上	170元/件
	1-1000件	160元/件
	1001-2000件	155元/件
T恤	2001-3000件	150元/件
	3001-4000件	145元/件
	4001-5000件	140元/件
	5000件以上	135元/件
牛仔裤	1-1000件	270元/件
	1001-2000件	265元/件
	2001-3000件	260元/件

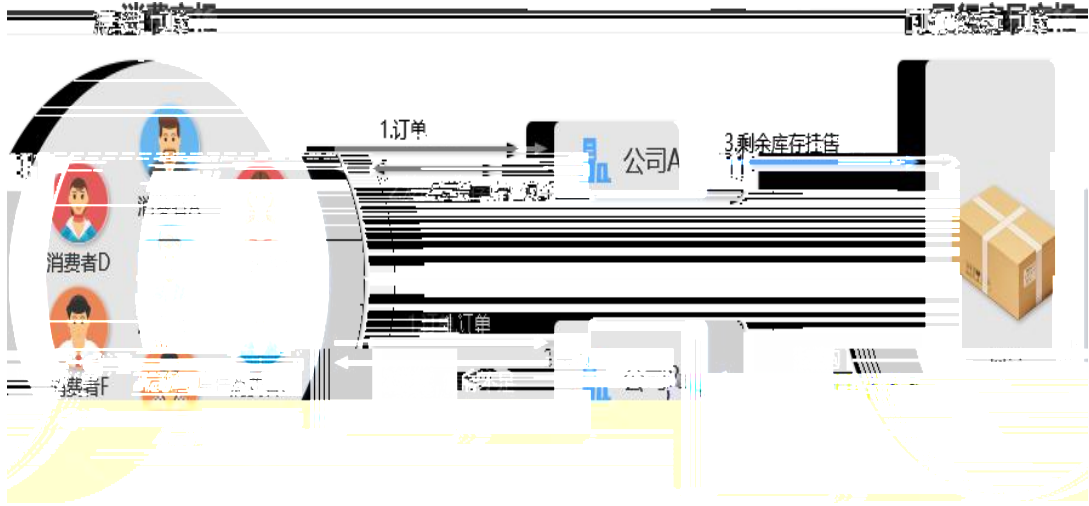

5

APP

6

200

1

2

	172. 16. 0. 131/	
		48
		3
		1

3

90

10	10	6S 3 /3 /4	
90	10	A 2 2 2 4	
	10	5 5	
	10	5 2 3	
	APP	5 10	
	15	5 10	
	10	5 5	
	10	5 3 2	
	10	5 5	
	100		

2.

3-2

1
1

200

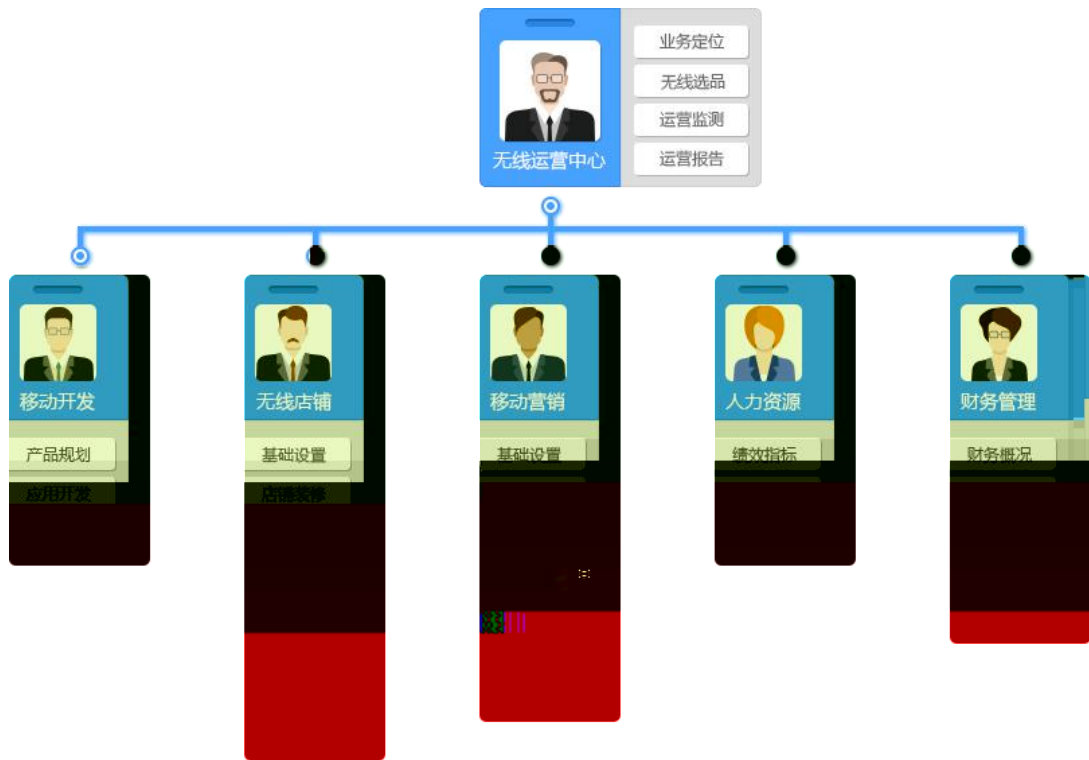

2

4

T

T

选品参考数据：市场交易热度

 圈越大表示该品类商品越热销

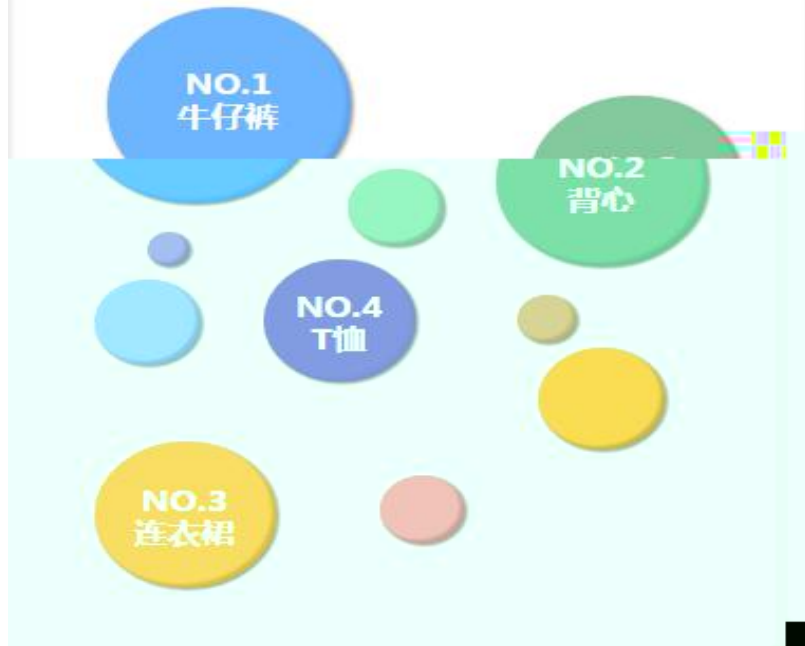



4)

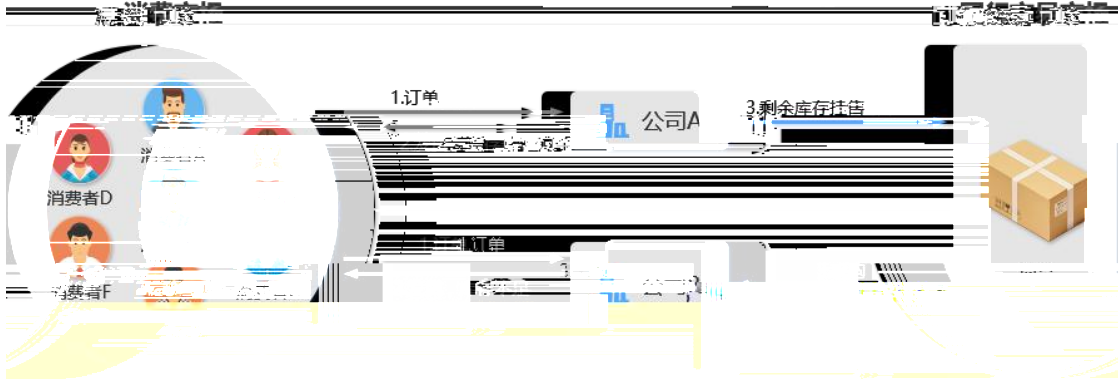

5

APP

6

200

3-2

10	10	6S 3 /3 /4	
90			
		10	A 2 2 2 4
		10	5 5
		10	5 2 3
	APP	15	5 10
		15	5 10
		10	5 5
		10	5 3 2
		10	5 5
		100	

3.

3-3

1
1

200

2

4



3

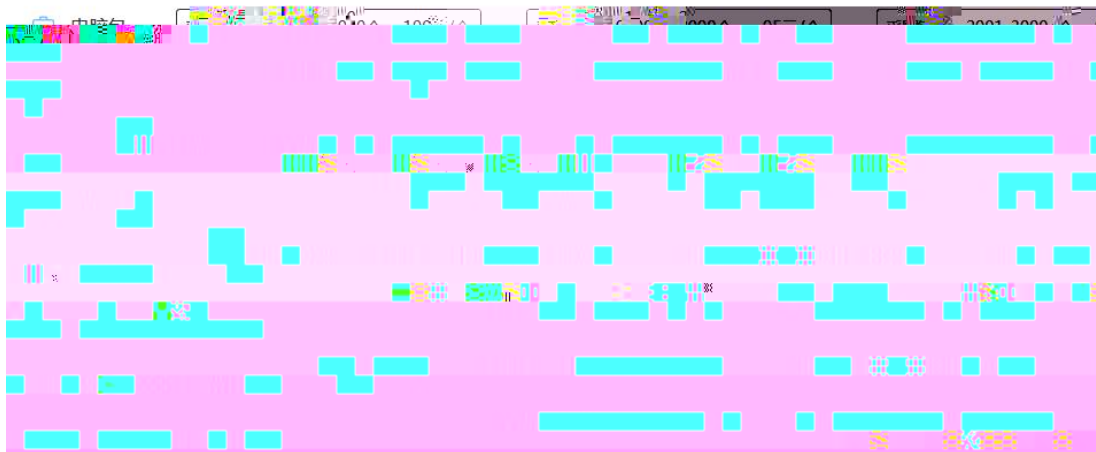

4

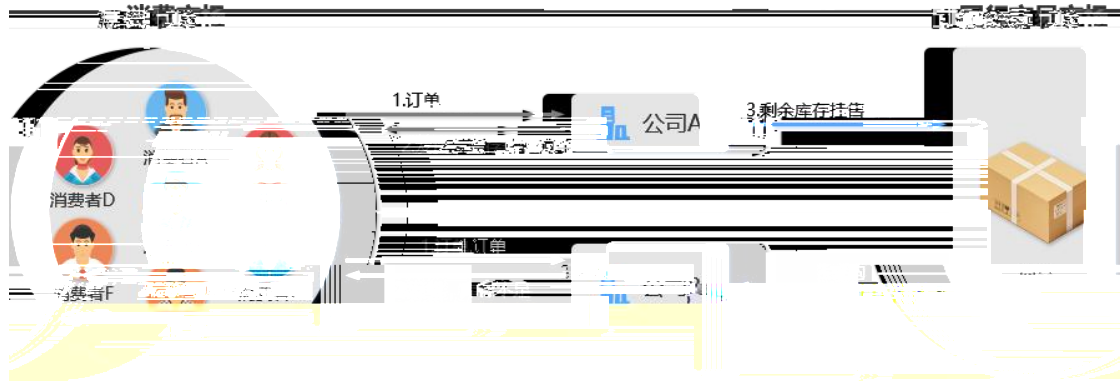

5

APP

6

200

1

2

	172.16.0.131/	
		48
		3
		1

3

90

4

3-3

3-3

10	10	6S 3 /3 /4	
90			
		10	A 2 2 2 4
		10	5 5
		10	5 2 3
	APP	15	5 10
		15	5 10
		10	5 5
		10	5 3 2
		10	5 5
		100	

4.

3-4

1
1

200

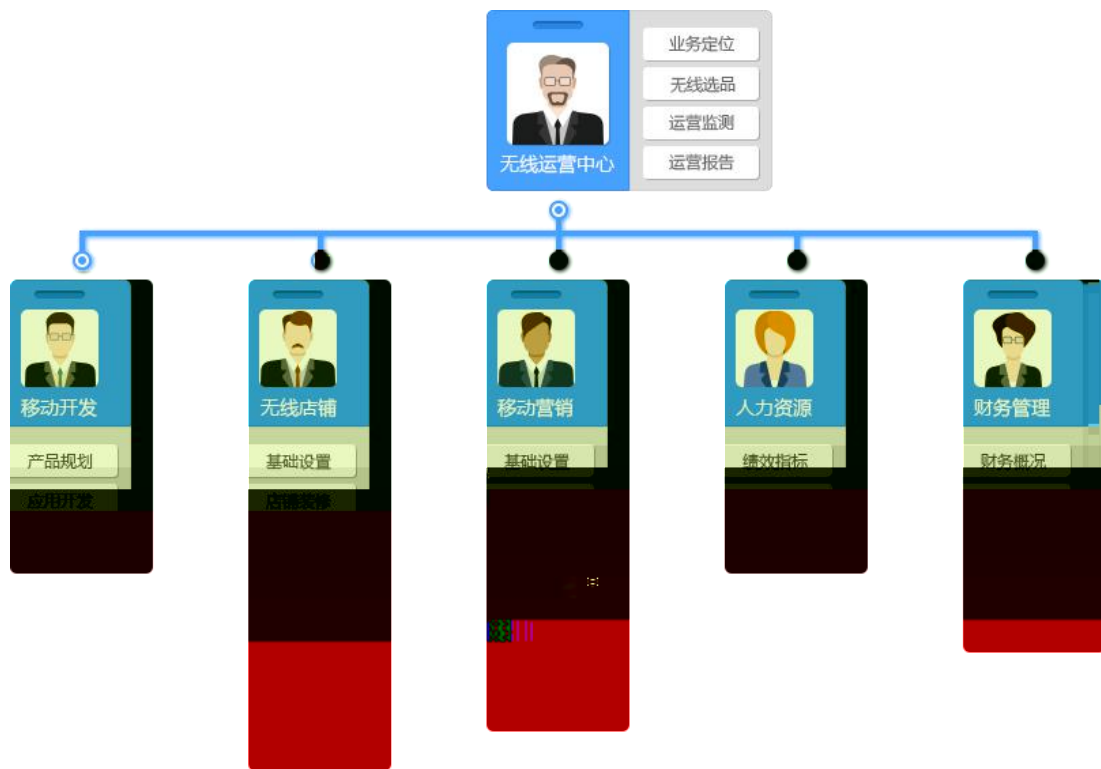

2

4

选品参考数据：市场交易热度

 圈越大表示该品类商品越热销



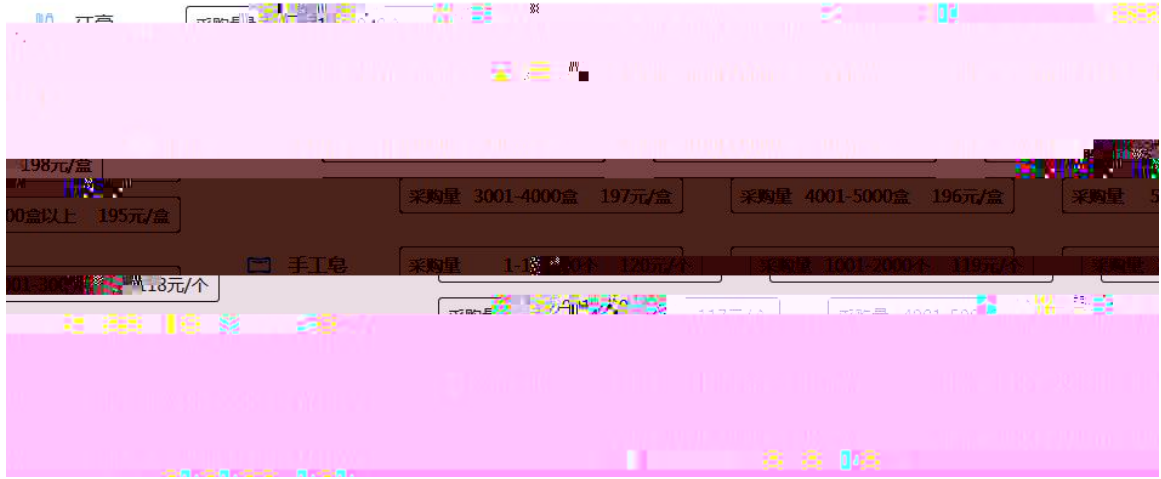

4



3-4

10	10	6S 3 /3 /4	
90	10	A	2 2 2 4
		10	5 5
			5
	10	2	3
		15	5 10
		15	5 10
	10	5 5	
		10	5 3 2
		10	5 5
		100	

5. 3-5

1
1

200

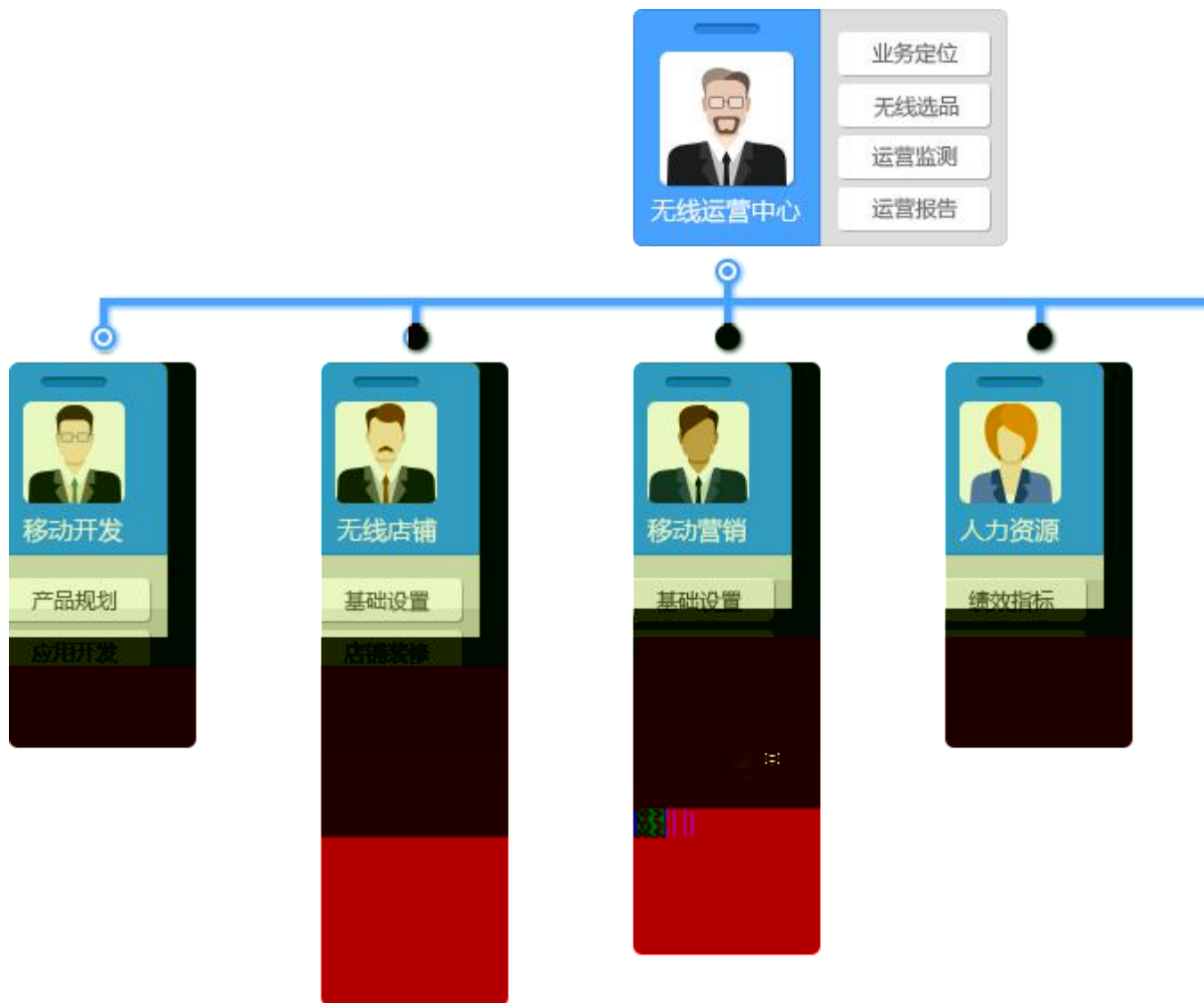

2

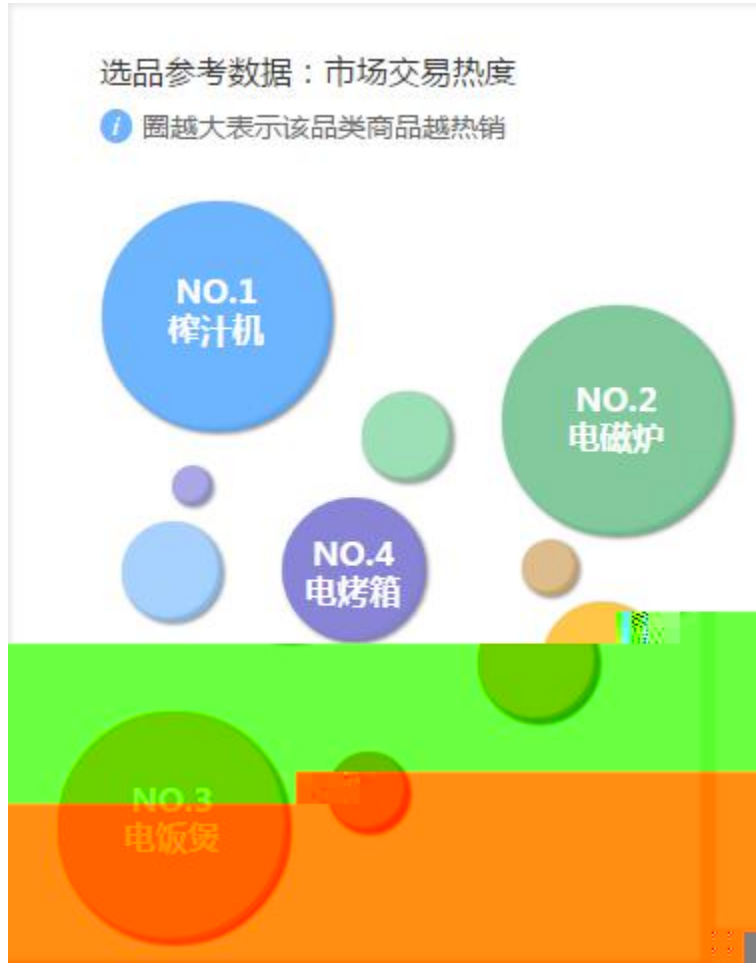



4

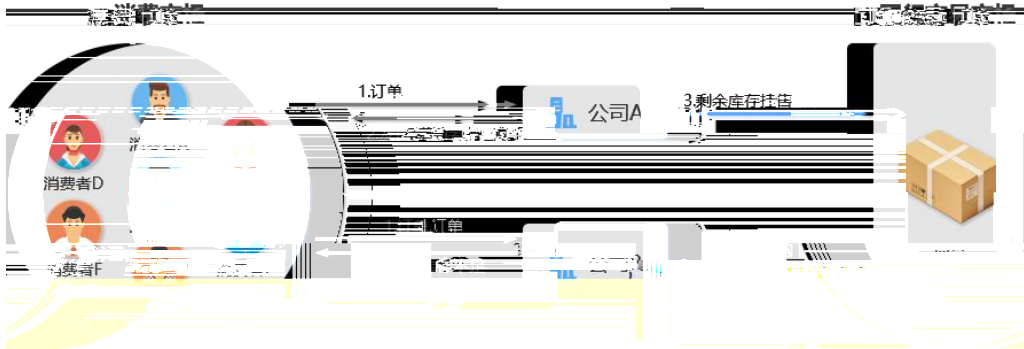

5

APP

6

200



2

	172. 16. 0. 131/	
	48	
	3 1	

3

90

4

3-5

10	10	6S 3 /3 /4	
90			
		10	A 2 2 2 4
		10	5 5
		10	5 2 3
	APP	15	5 10
		15	5 10
		10	5 5
		10	5 3 2
		10	5 5
		100	

6. 3-6

1
1

200

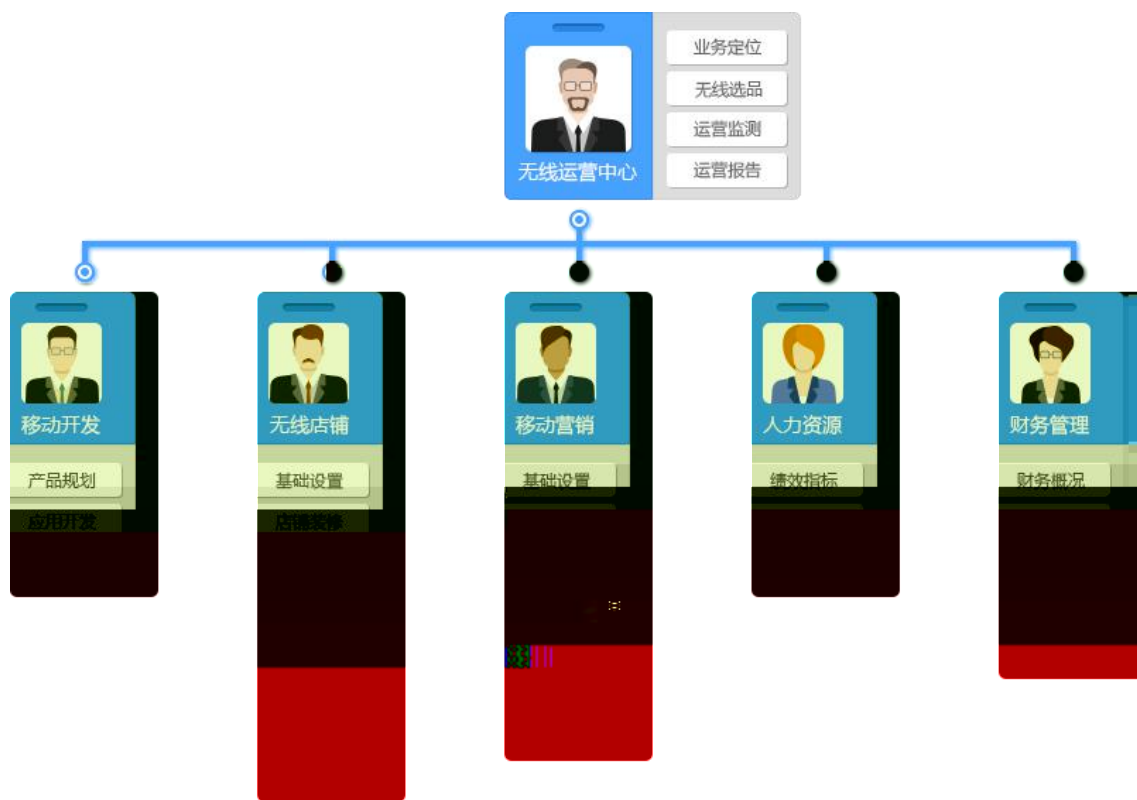

2

4

选品参考数据：市场交易热度

圈越大表示该品类商品越热销

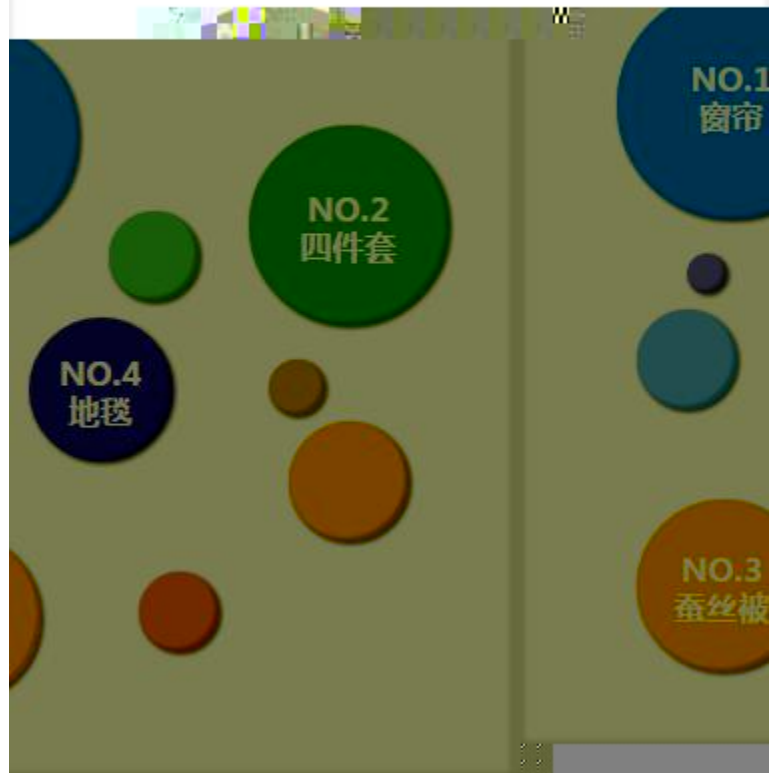

10套 290元/套	采购量 1-1000套 300元/套	采购量 1001-2000套 295元/套	采购量 2001-3000套 290元/套
以上 275元/套	采购量 3001-4000套 285元/套	采购量 4001-5000套 280元/套	采购量 5000套以上 275元/套
10床 440元/床	采购量 1-1000床 430元/床	采购量 1001-2000床 445元/床	采购量 2001-3000床 440元/床
以上 425元/床	采购量 3001-4000床 435元/床	采购量 4001-5000床 430元/床	采购量 5000床以上 425元/床
101-300米 190元/米	采购量 1-1000米 200元/米	采购量 1001-2000米 195元/米	采购量 2001-3000米 190元/米
以上 180元/米	采购量 3001-4000米 195元/米	采购量 4001-5000米 190元/米	采购量 5000米以上 180元/米

4

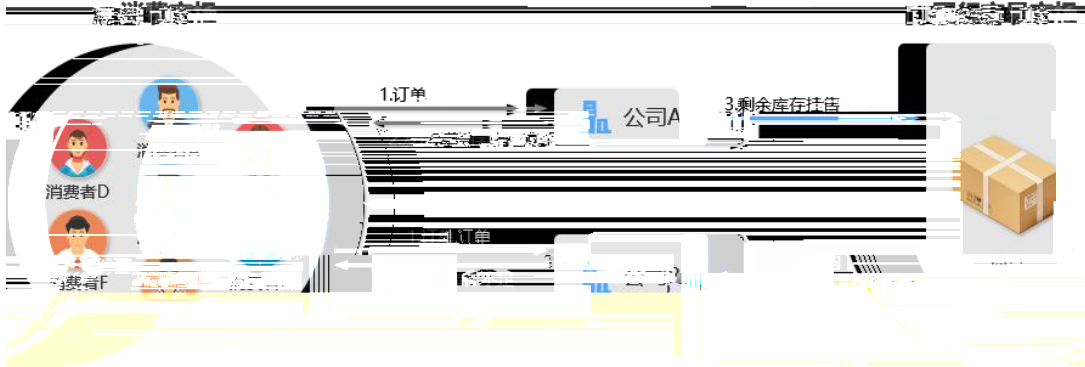

5

APP

6

200

1

2

	172.16.0.131/	
	48	
	3 1	

3

90

4

3-6

3-6



7. 3-7

1
1

200

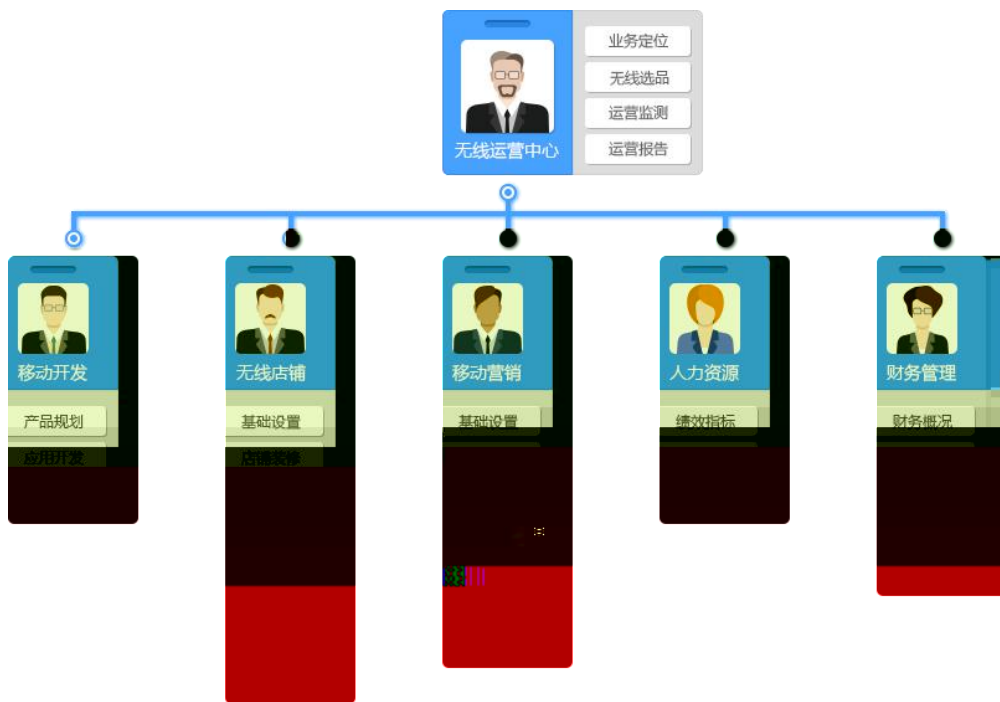

2

4

选品参考数据：市场交易热度

 圈越大表示该品类商品越热销



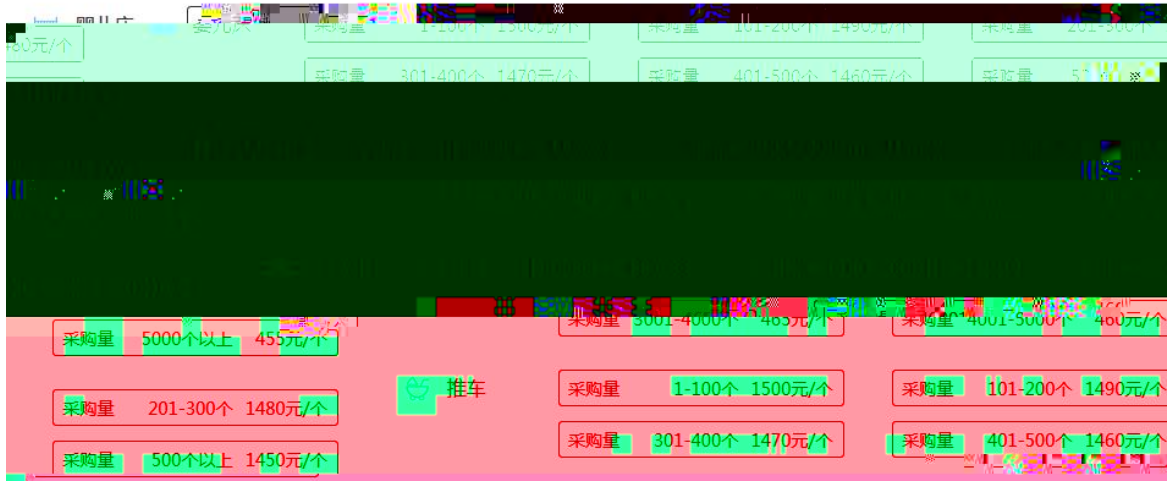

4

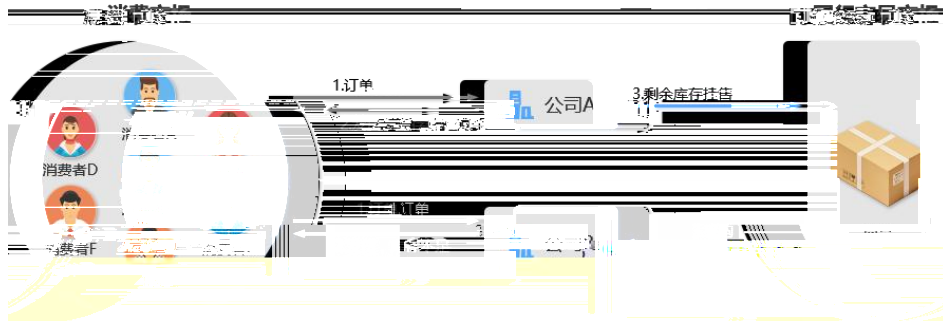

5

APP

6

200

2

	172. 16. 0. 131/	
		48
	3 1	

3

90

4

3-7

3-7

10	10	6S	
		3 /3 /4	
90			
		10	A 2 2 2 4
		10	5
			5
		10	5
			2
			3
	APP	15	5 10
		15	5 10
		10	5 5
	10	5 3 2	
	10	5 5	
	100		

8.

3-8

1
1

200

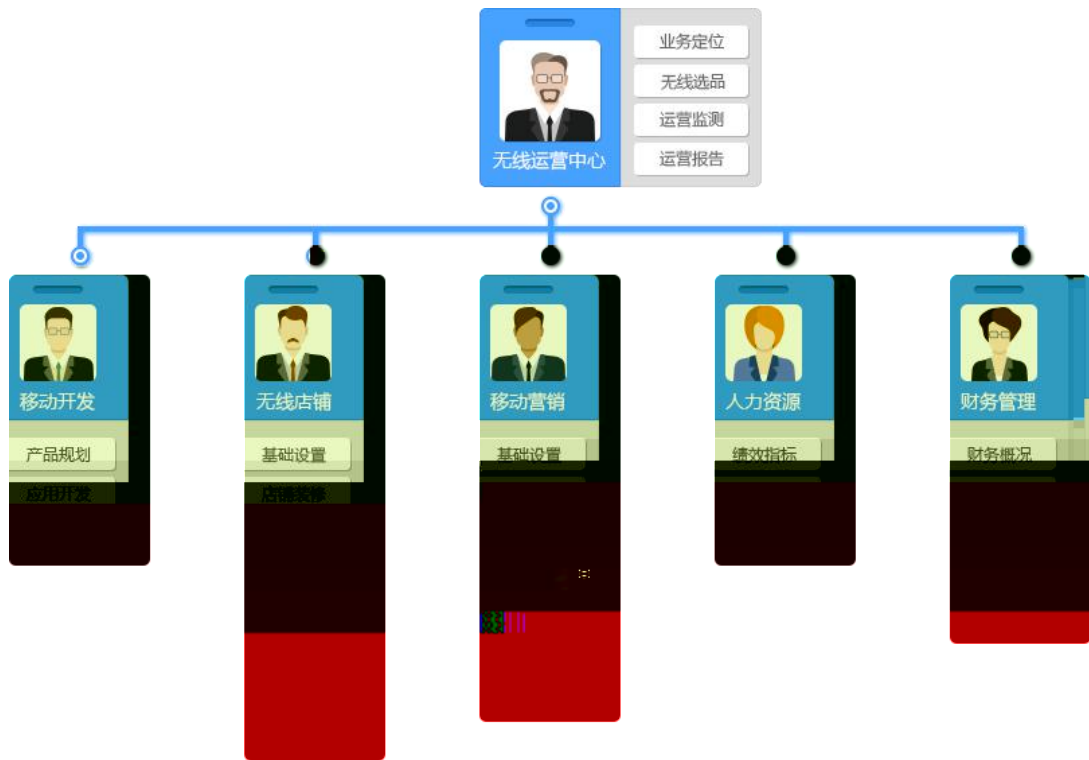

2

4

选品参考数据：市场交易热度

! 圈越大表示该品类商品越热销

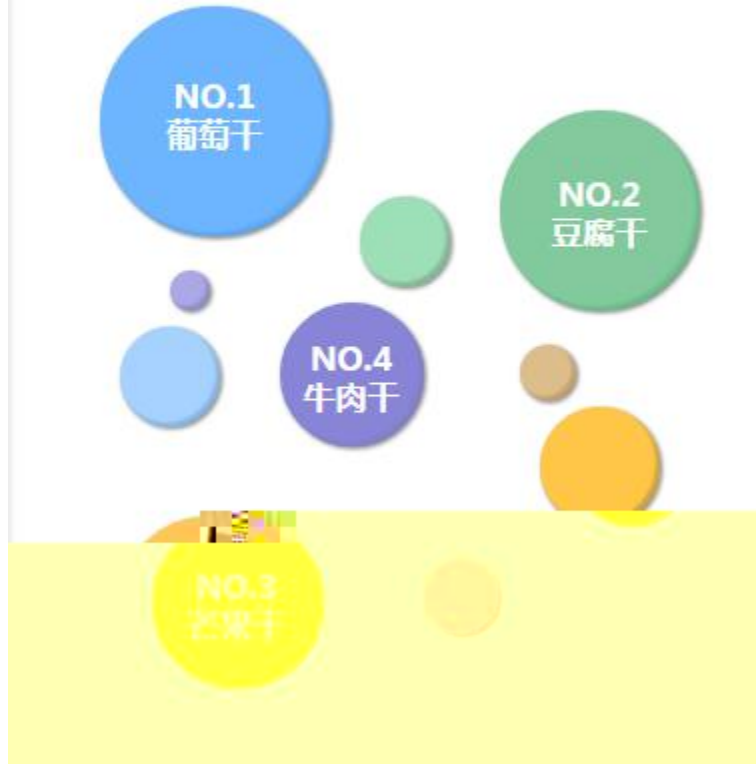



4

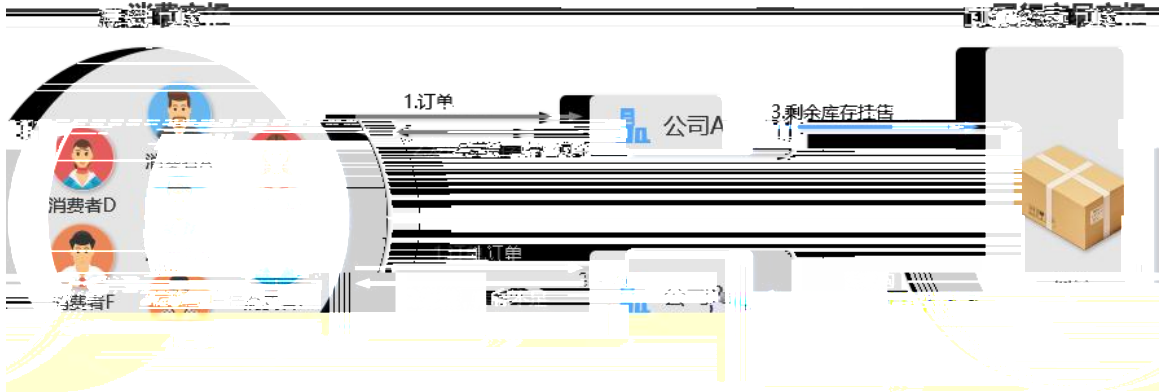

5

APP

6

200

1

2

	172.16.0.131/	
	48	
	3 1	

3

90

4

3-8

3-8

10	10	6S 3 /3 /4	
90			
		10	A 2 2 2 4
		10	5 5
		10	5 2 3
	APP	15	5 10
		15	5 10
		10	5 5
		10	5 3 2
		10	5 5
		100	

9.

3-9

1
1

200

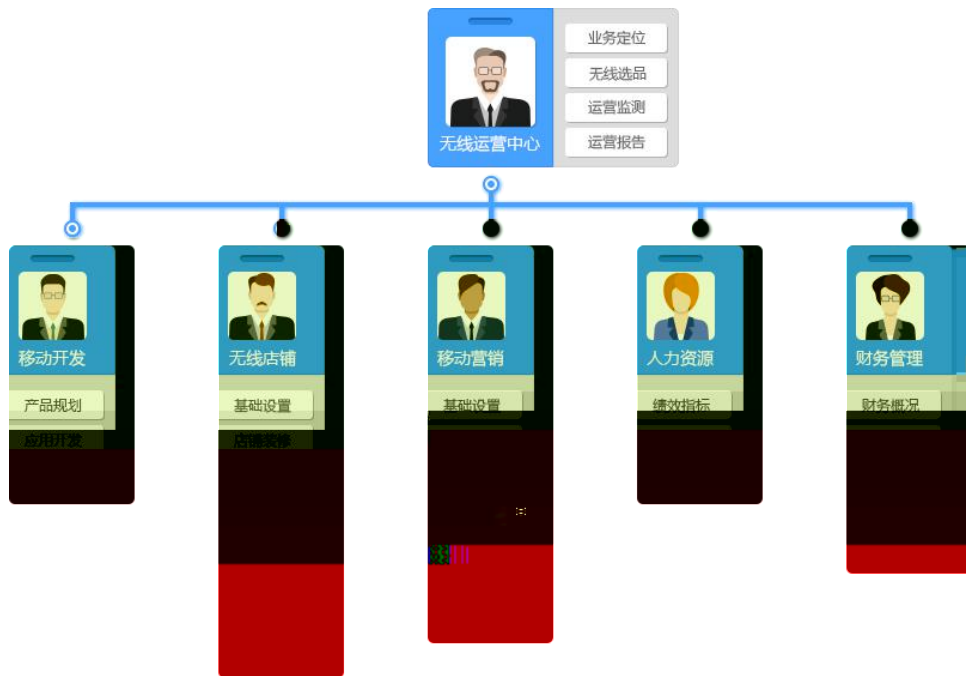

2

4

选品参考数据：市场交易热度

 圈越大表示该品类商品越热销



平板电脑	采购量 1-100个 3000元/个	采购量 101-200个 2950元/个	采购量 201-300个 2900元/个
笔记本电脑	采购量 1-100个 6000元/个	采购量 101-200个 5990元/个	采购量 201-300个 5980元/个
数码相机	采购量 1-3000个 190元/个	采购量 301-400个 2970元/个	采购量 401-500个 2960元/个
数码相机	采购量 1-1000个 200元/个	采购量 1001-2000个 195元/个	采购量 2001-3000个 190元/个

4

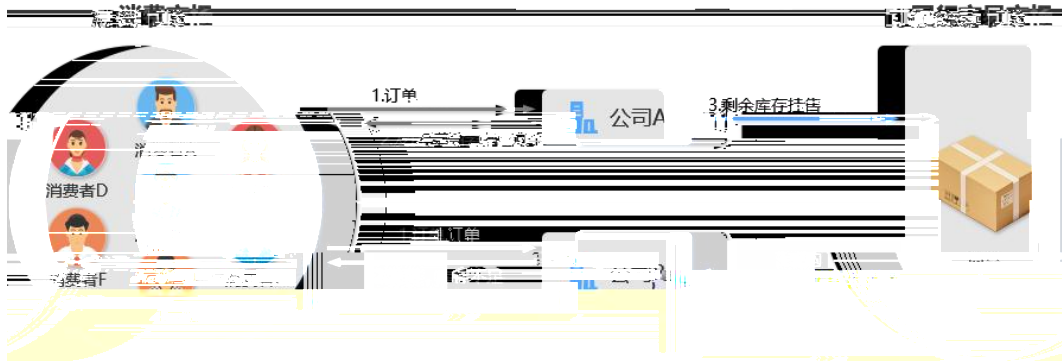

5

APP

6

200

1

2

	172. 16. 0. 131/	
	48	
	3 1	

3

90

4

3-9

3-9

10	10		6S 3 /3 /4
90		10	A 2 2 2 4
		10	5 5
		10	5 2 3
	APP	15	5 10
		15	5 10
		10	5 5
		10	5 3 2
		10	5 5
		100	

10. 3-10

1
1)

200

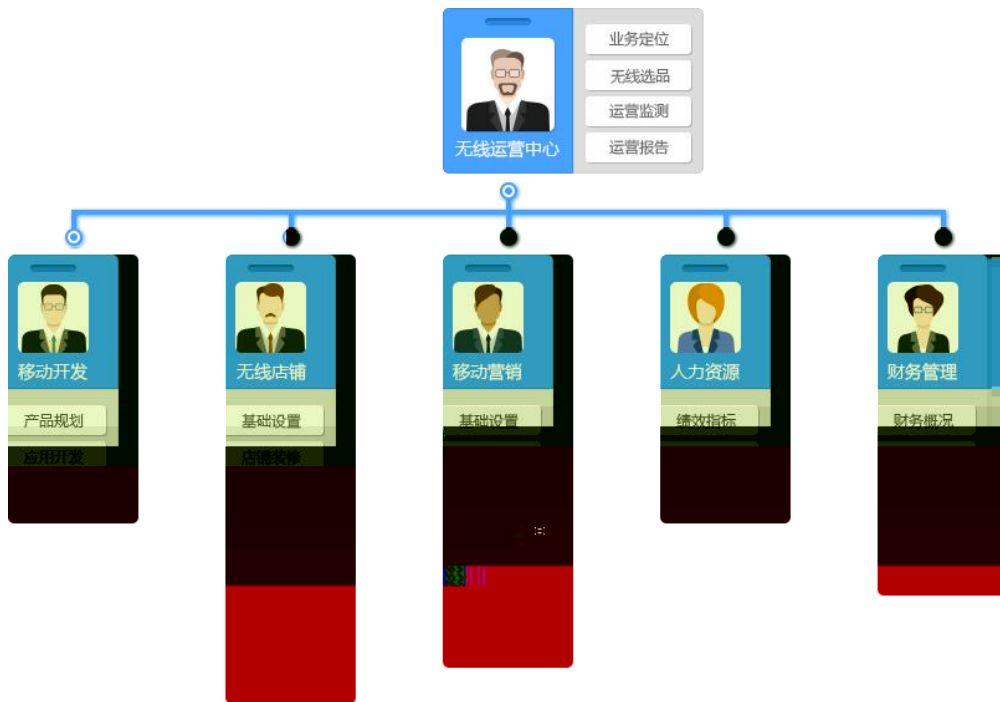

2)

4

选品参考数据：市场交易热度

 圈越大表示该品类商品越热销



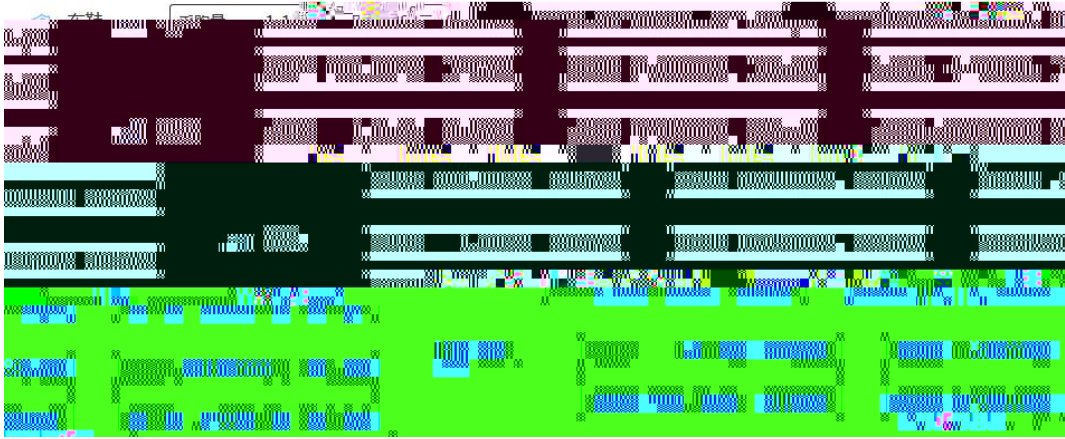

4)

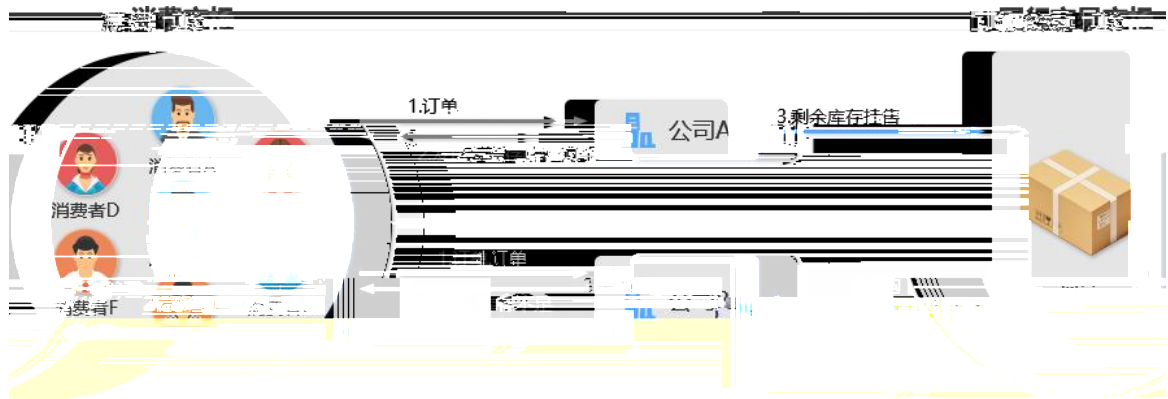

5

APP

6

2

	172. 16. 0. 131/	
	48	
	3 1	

3

90

4

10	10	6S 3 /3 /4	
90	10	A 2 2 2 4	
	10	5 5	
	10	5 2 3	
	APP	5 10	
	15	5 10	
	10	5 5	
	10	5 3 2	
	10	5 5	
	100		

11.

3

(10)	10	/4 /6 /10	0
(90)	10	120*120	
		0 /4 /6 /8 /10	
	5	50	
		0 /1 /2 /3 /4 /5	
	5		
		0 /1 /2 /3 /4 /5	
	5	1 2	2
	20	150 618	
	0 /5 /10 /15/20		
20	1		
	200		
	0 /5 /10 /15/20		
3G	5		
	20		
		0 /5 /10 /15/20	
	100		

12. 3-12

1

1

2

3

:

(10)	10	/4 /6 /10	0	
(90)	10	120*120 0 /4 /6 /8 /10		
	5	50 0 /1 /2 /3 /4 /5		
	5	0 /1 /2 /3 /4 /5		
	5	1 2	2	
		150 618 0 /5 /10 /15/20		
	20	1 200 0 /5 /10 /15/20		
	3G	5		
		20	0 /5 /10 /15/20	
	100			

13. 3-13

1

1

2

3 :

4

5 6.18 11

1

11 6.18

6

1

200

7 3G 10 3G

8

2

7 8 0 2007 P

CS6.0

GOOGLE48

://172.16.0.131/ /

3

(10)	10	/4 /6 /10	0	
(90)	10	120*120 0 /4 /6 /8 /10		
	5	50 0 /1 /2 /3 /4 /5		
	5	0 /1 /2 /3 /4 /5		
	5	1 2	2	
		150 618 0 /5 /10 /15/20		
	20	1 200 0 /5 /10 /15/20		
	3G	5		
		20	0 /5 /10 /15/20	
	100			

14. 3-14

1

1

2

3 :

4

5 6.18 11

1

11 6.18

6

1

200

7 3G 10 3G

8

2

7 8 0 2007 P

CS6.0

GOOGLE48

://172.16.0.131/

/

3

90

(10)	10	/4 /6 /10	0
(90)	10	120*120	
		0 /4 /6 /8 /10	
	5	50	
		0 /1 /2 /3 /4 /5	
	5		
		0 /1 /2 /3 /4 /5	
	5	1 2	2
	20	150 618	
		0 /5 /10 /15/20	
	20	1	
	200		
	0 /5 /10 /15/20		
3G	5		
	20		
		0 /5 /10 /15/20	
	100		

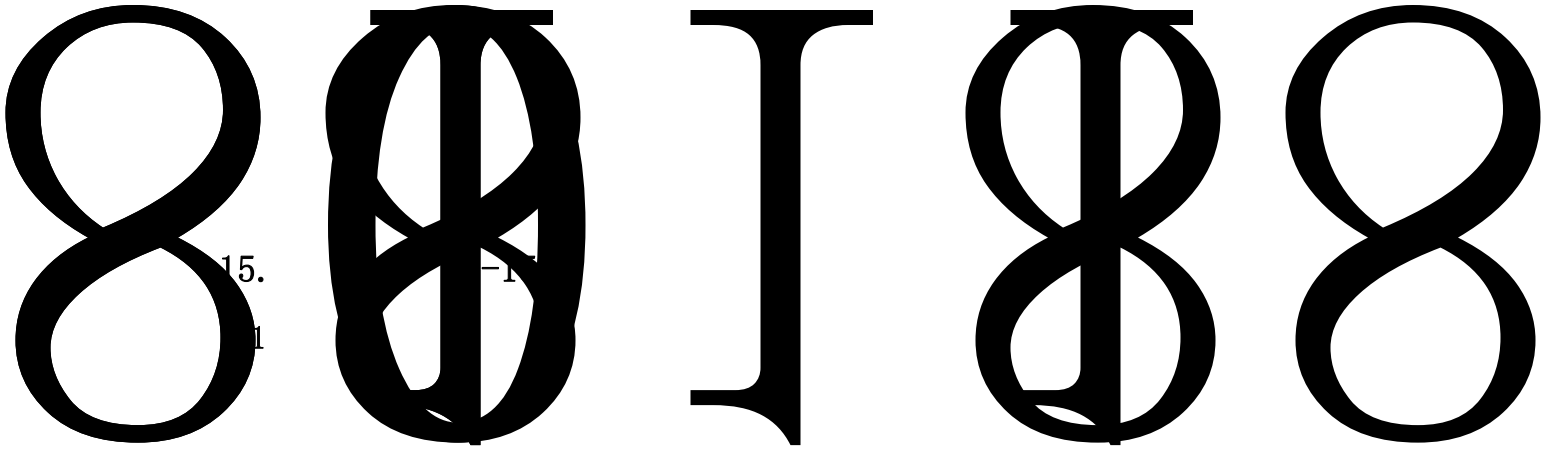

15.
1

-1

1

2

3

:

4

5

6.18 11

1

11 6.18

6

1

200

7 3G

10

3G

8

"

2

7

8

0

2007

P

(10)	10	/4 /6 /10	0
(90)	10	120*120	
		0 /4 /6 /8 /10	
	5	50	
		0 /1 /2 /3 /4 /5	
	5		
		0 /1 /2 /3 /4 /5	
	5	1 2	2
	20	150 618	
		0 /5 /10 /15/20	
	20	1	
	200		
	0 /5 /10 /15/20		
3G	5		
	20		
		0 /5 /10 /15/20	
	100		

16. 3-16

1

1

2

3 :

4

5 6.18 11

1

11 6.18

6

1

200

7 3G 10 3G

8

2

7 8 0 2007 P

CS6.0

GOOGLE48

://172.16.0.131/ /

3

90

(10)	10	/4 /6 /10	0
(90)	10	120*120	
		0 /4 /6 /8 /10	
	5	50	
		0 /1 /2 /3 /4 /5	
	5		
		0 /1 /2 /3 /4 /5	
	5	1 2	2
	20	150 618	
		0 /5 /10 /15/20	
	20	1	
	200		
	0 /5 /10 /15/20		
3G	5		
	20		
		0 /5 /10 /15/20	
	100		

17. 3-17

1

1

2

3 :

4

5 6.18 11

1

11 6.18

6

1

200

7 3G 10 3G

8

2

7 8 0 2007 P

CS6.0 GOOGLE48

://172.16.0.131/ /

3

90

(10)	10	/4 /6 /10	0	
(90)	10	120*120 0 /4 /6 /8 /10		
	5	50 0 /1 /2 /3 /4 /5		
	5	0 /1 /2 /3 /4 /5		
	5	1 2 2		
	20	150 618 0 /5 /10 /15/20		
	20	1 200 0 /5 /10 /15/20		
	3G	5		
		20	0 /5 /10 /15/20	
		100		

18. 3-18

1

1

2

3 :

4

5 6.18 11

1

11 6.18

6

1

200

7 3G 10 3G

8

2

7 8 0 2007 P

CS6.0 GOOGLE48

://172.16.0.131/ /

3

90

(10)	10	/4 /6 /10	0
(90)	10	120*120	
		0 /4 /6 /8 /10	
	5	50	
		0 /1 /2 /3 /4 /5	
	5		
		0 /1 /2 /3 /4 /5	
	5	1 2	2
	20	150 618	
		0 /5 /10 /15/20	
	20	1	
	200		
	0 /5 /10 /15/20		
3G	5		
	20		
		0 /5 /10 /15/20	
	100		

19. 3-19

1

1

2

3 :

4

5 6.18 11

1

11 6.18

6

1

200

7 3G 10 3G

8

2

7 8 0 2007 P

CS6.0 GOOGLE48

://172.16.0.131/ /

3

90

(10)	10	/4 /6 /10	0
(90)	10	120*120	
		0 /4 /6 /8 /10	
	5	50	
		0 /1 /2 /3 /4 /5	
	5		
		0 /1 /2 /3 /4 /5	
	5	1 2	2
	20	150 618	
		0 /5 /10 /15/20	
	20	1	
	200		
	0 /5 /10 /15/20		
3G	5		
	20		
		0 /5 /10 /15/20	
	100		

20. 3-20

1

1

2

3 :

4

5 6.18 11

1

11 6.18

6

1

200

7 3G 10 3G

8

2

7 8 0 2007 P

CS6.0

GOOGLE48

://172.16.0.131/

/

3

90

(10)	10	/4 /6 /10	0
(90)	10	120*120	
		0 /4 /6 /8 /10	
	5	50	
		0 /1 /2 /3 /4 /5	
	5		
		0 /1 /2 /3 /4 /5	
	5	1 2	2
	20	150 618	
		0 /5 /10 /15/20	
	20	1	
	200		
	0 /5 /10 /15/20		
3G	5		
	20		
		0 /5 /10 /15/20	
	100		

1. 4-1

1

1

7

1000

.

.

2010 4

5000

+

+

+

2

a.

b.

50

c.

10

d.

50

1		

e.

100

1		
2		
3		

f.

400

1			
2			
3			

g.

h.

3

2

7 8 0 2007 H S

3

60

4

(4-1)

4-1

	10	6S 0 /3 /5 0 /3 /5	
	5		
	5	1	10
	5	2 1	
	5		2
	10	3 10 1	
	10	4 6 20	
	40	1	
	40	4 36	
	10	40 1	
	10		2
		8	
	10		2 8
	100		

2.

4-2

1

1

www.168gld.com

1997 3 20

500

2017

2500

0

2

d.

50

1		

e.

100

1		
2		
3		

f.

400

1			
2			
3			

g.

h.

3

2

3

60

4

(4-2)

4-2

	10	6S 0 /3 /5 0 /3 /5	
	5		
	5	1	10
	5	2 1	
	5		2
	10	1	3 10 1
	10	1	4 6 20
	40	40 1	4 36
	10		8 2
10		2 8	
	100		

3. 4-3

1
1

www.hnaijia.cn

1200

2014 03 18

49

17

4508

2

a.

b.

50

c.

10

d.

50

1		

e.

100

1		

2		
3		

f.

400

1			
2			
3			

g.

h.

3

2

7 8 0 2007 H S

3

60

4

(4-3)

4-3

	10	6S 0 /3 /5 0 /3 /5	
	5		
	5	1	10
	5	2 1	
	5		2
	10	1	3 10 1 4 6 20
	40	40 1	4 36
	10		2
	10		8
	100	2 8	

4. 4-4

1
1

www.hnxffs.com

1996

AAA	2011		21
		58	5088
336		35	50
			66
20		165	

	CAD	2	6
	7		
41			

	1996	
2008	ISO9001	ISO14001
2011		
()		

2

a.

b.

50

c. 10

d.

50

1		

e.

100

1		
2		
3		

f.

400

1			
2			
3			

g.

h.

3

2

7 8 0 2007 H S

3

60

4

(4-4)

4-4

	10	6S 0 /3 /5 0 /3 /5	
	5		
	5	1	10
	5	2 1	
	5		2 3 10 1
	10	1	4 6 20
	40	40 1	4 36
	10		2 8
	10		2 8
	100		

5. 4-5

1
1

www.cschanglong.com 1985
2007

2007
A 2008
2012

2011 fs.changsha.cn
2012

2

a.

b. 50

c. 10

d.

50

1		

e.

100

1		
2		
3		

f.

400

1			
2			
3			

g.

h.

3

2

3

60

4

(4-5)

4-5

	10	6S 0 /3 /5 0 /3 /5	
	5		
	5	1	10
	5	2 1	
	5		2
	10	1	3 10 1
	10	1	4 6 20
	40	40 1	4 36
	10		8 2
10		2 8	
	100		

6. 4-6

1
1

<http://www.and169.com>

2006

5000

2

a.

b.

50

c.

10

d.

50

1		

e.

100

1		
2		
3		

f.

400

1			
2			
3			

g.

h.

3

2

7 8 0 2007 H S

3

60

4

(4-6)

4-6

	10	6S 0 /3 /5 0 /3 /5	
	5		
	5	1	10
	5	2 1	
	5		2
	10	3 10 1	
	10	4 6 20	
	40	1	
	40	4 36	
	10	40 1	
	10		2
		8	
	10		2 8
	100		

7. 4-7

1
1

<http://www.csqstx.com>

-

2

a.

b.

50

c.

10

d.

50

1		

e.

100

1		
2		
3		

f.

400

1			
2			
3			

g.

h.

3

2

7 8 0 2007 H S

3

60

4

(4-7)

4-7

	10	6S 0 /3 /5 0 /3 /5	
	5		
	5	1	10
	5	2 1	
	5		2
	10	3 10 1	
	10	4 6 20	
	40	1	
	40	4 36	
	10	40 1	
	10		2
		8	
	10		2 8
	100		

8. 4-8

1
1

<http://www.cstycb.com>

2016

10

2

a.

b.

50

c.

10

d.

50

1		

e.

100

1		
2		
3		

f.

400

1			
2			
3			

g.

h.

3

2

7 8 0 2007 H S

3

60

4

(4-8)

4-8

	10	6S 0 /3 /5 0 /3 /5	
	5		
	5	1	10
	5	2 1	
	5	3 10 1	2
	10	4 6 20	1
	40	40 4 1 36	
	10	8	2
	10	2 8	
	100		

9. 4-9

1
1

2016 3 22

3000

20

2

a.

b. 50

c. 10

d.

50

1		

e.

100

1		
2		
3		

f.

400

1			
2			
3			

g.

h.

3

2

7 8 0 2007 H S

3

60

4

(4-9

4-9

	10	6S 0 /3 /5 0 /3 /5	
	5		
	5	1	10
	5	2	1
	5	2	3 10 1
	10	20 1	4 6
	40	40 1	4 36
	10		8 2
	10		2 8
	100		

10. 4-10

1
1

www.bidanxi.com 2010 2012

3

21

50

2

a.

b.

50

c.

10

d.

50

1		

e.

100

1		
2		
3		

f.

400

1			
2			
3			

g.

h.

3

2

7 8 0 2007 H S

3

4-10

	10	6S 0 /3 /5 0 /3 /5	
	5		
	5	1	10
	5	2	1
	5	2	3 10 1
	10	20 1	4 6
	40	40 1	4 36
	10		8 2
	10		2 8
	100		

1. 5-1

1

1

58

1150 520 76900 9 30-
12 30 14 00-18 30 19 30-23 00

2

3

2

7 8 0 2010

3

60

4

(5-1)

5-1

10	10	◆	5	600	
		◆	20 1		
			5		
	10	◆		2	1.
		◆		2	200
		◆		3	1
		◆	3		2.
		◆	5	4	30000 1
	20	1.	2		3
		2.			20
		10	2		1
		20			4.
90		◆	10		35
		◆		10	5.
	40	◆	10		
		◆		10	
		◆			1
			1-4		
	20	◆	4		
			1 5 20		
			100		

2. 5-2

1

1

68

780

405

77030

9 30-12 00 13 00-18:00 19:00- 22 30

2

:

2

7 8 0 2010

3

60

4

(5-2)

5-2

10	10	◆	5	600	
		◆	20 1		
			5		
	10	◆		2	1.
		◆		2	200
		◆		3	1
		◆	3		2.
		◆	5	4	30000 1
	20	1.	2		3
		2.			20
		10	2		1
		20			4.
90		◆	10		35
		◆		10	5.
	40	◆	10		
		◆		10	
		◆			1
			1-4		
	20	◆	4		
			1 5 20		
			100		

3. 5-3

1

1

48

980

268

300000

10 00-14 00 16 00-23 00

2

:

2

7 8

0 2010

3

60

4

(5-3)

5-3

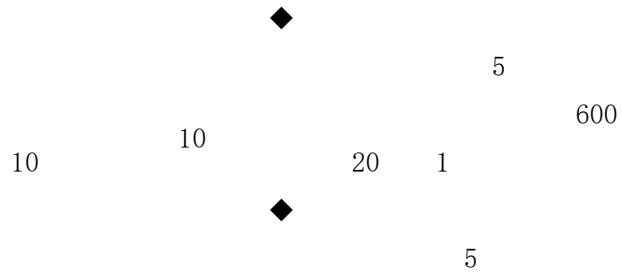

1. 200

1

2.

30000 1

3

20

1

4.

35

5.

1

4. 5-4

1

1

68

1600

560

38900

8 30-12 00 14 00-17

30 18 30-22 30

2

:

2

7 8 0 2010

3

60

4

(5-4)

5-4

10	10	◆	5	600	
		◆	20 1		
			5		
90	10	◆		2	1.
		◆		2	200
		◆		3	1
		◆	3		2.
	20	◆	5	4	30000 1
			1.	2	3
			2.		20
			10	2	1
			20		4.
	40	◆	10		35
		◆		10	5.
		◆	10		
		◆		10	
		◆			1
			1-4		
	20	◆	4		
			1	5	20
			100		

5. 5-5

1

1

T

145

1500

732

13500

9 30-12 30 14 00-18 30 19 30-23

00

2

:

2

7 8

0 2010

3

60

4

(5-5)

5-5

10	10	◆	5	600	
		◆	20 1		
			5		
	10	◆		2	1.
		◆		2	200
		◆		3	1
		◆	3		2.
		◆	5	4	30000 1
	20	1.	2		3
		2.			20
		10	2		1
		20			4.
90		◆	10		35
		◆		10	5.
	40	◆	10		
		◆		10	
		◆			1
			1-4		
	20	◆	4		
			1 5 20		
			100		

6. 5-6

1

1

2004

200

980

125

215000

9 30-12 30 14 00-18 30 19 30-23 00

2

:

2

7 8 0 2010

3

60

4

(5-6)

5-6

10	10	◆	5	600	
		◆	20 1		
			5		
	10	◆		2	1.
		◆		2	200
		◆		3	1
		◆	3		2.
		◆	5	4	30000 1
	20	1.	2		3
		2.			20
		10	2		1
		20			4.
90		◆	10		35
		◆		10	5.
	40	◆	10		
		◆		10	
		◆			1
			1-4		
	20	◆	4		
			1 5 20		
			100		

7. 5-7

1

1

65

780

110

340000

10 00-14 00 16 00-23 00

2

:

2

7 8 0 2010

3

60

4

(5-7)

5-7

10	10	◆	5	600	
		◆	20 1		
			5		
	10	◆		2	1.
		◆		2	200
		◆		3	1
		◆	3		2.
		◆	5	4	30000 1
	20	1.	2		3
		2.			20
		10	2		1
		20			4.
90		◆	10		35
		◆		10	5.
	40	◆	10		
		◆		10	
		◆			1
			1-4		
	20	◆	4		
			1 5 20		
			100		

8. 5-8

1

1

170

260

870

26100

9 30-12 00 13 00-18:00 19:00- 22 30

2

:

2

7 8

0 2010

3

60

4

(5-8)

5-8

10	10	◆	5	600	
		◆	20 1		
			5		
	10	◆		2	1.
		◆		2	200
		◆		3	1
		◆	3		2.
		◆	5	4	30000 1
	20	1.	2		3
		2.			20
		10	2		1
		20			4.
90		◆	10		35
		◆		10	5.
	40	◆	10		
		◆		10	
		◆			1
			1-4		
	20	◆	4		
			1 5 20		
			100		

9. 5-9

1

1

80

980

280

52750

10 00-14 00 16 00-23

00

2

:

2

7 8

0 2010

3

60

4

(5-9)

10. 5-10

1

1

78

170

240

15600

8 30-12 00 14 00-17 30 18

30-22 30

2

:

2

7 8

0 2010

3

60

4

(5-10)

5-10

10	10	◆	5	600	
		◆	20 1		
			5		
90	10	◆		2	1.
		◆		2	200
		◆		3	1
		◆			2.
			3		
	20	◆	5	4	30000 1
			1.	2	3
			2.		20
			10	2	1
			20		4.
	40	◆	10		35
		◆		10	5.
		◆			
		◆	10	10	
		◆		10	1
			1-4		
	20	◆	4		
				1 5 20	
		100			

